

2023

CATÁLOGO CATALOG 2023

CLAR SYSTEMS DISEÑA, FABRICA
Y DISTRIBUYE SOLUCIONES PROFESIONALES PARA
LA HIGIENE INDUSTRIAL Y COLECTIVIDADES

CLAR SYSTEMS DESIGNS, MANUFACTURES
AND DISTRIBUTES PROFESSIONAL SOLUTIONS
FOR INDUSTRIAL HYGIENE AND COLLECTIVITIES



Fabricante de calidad
Marca España

Made in Spain quality Manufacturer

clarsystems.com



ÍNDICE / INDEX

DISPENSADORES DE JABÓN

KYRA p 10-17

BELLA p 18-23

I-NOVA p 24-25

TRENDY p 36-37

ACCIONAMIENTO
MEDIANTE CODO p 26-27

ACERO INOX p 54-57



DISPENSADORES DE PAPEL TOALLA

I-NOVA p 32-33

TRENDY p 40-41

ACERO INOX p 54-57

AUTOCORTANTE p 46-47

PALANCA p 48-49

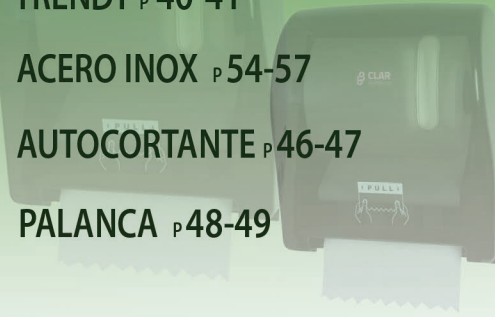

DISPENSADORES DE PAPEL CENTRICO MECHA

I-NOVA p 34-35

TRENDY p 42-43

ACERO INOX p 54-55



DISPENSADORES DE PAPEL HIGIENICO

KYRA p 6-7

I-NOVA p 28-31

TRENDY p 38-39
p 44-45

ACERO INOX p 54
p 57



DISPENSADORES DE BOBINA INDUSTRIAL

AUNIA p 52-53



DISPENSADORES DE FRAGANCIAS

ELECTRONIC p 74-75

FRAGANCIAS p 76-77



ELIMINADORES DE INSECTOS

ELECTRONIC p 68-69

GLUE BOARD p 70-72

LÁMINAS ADHESIVAS p 73



SECADORES DE MANO Y PELO

JET DRY p 58-59

ULTRA DRY p 60-61

FAST DRY p 62-63

TRENDY p 64-65

PROFESSIONAL p 66-67



ACCESORIOS Y PAPELERAS

PAPELERAS p 8-9 y p 93

LAGA p 80-82 TONDA p 83-85

COMPLEMENTOS DE DUCHA p 86-87

ESPEJOS Y DISPENSADORES p 88-91



CAMBIADORES INFANTILES

DIBUS p 78-79



COMPLEMENTOS Y AYUDAS TÉCNICAS

COMPLEMENTOS p 92-93

AYUDAS TÉCNICAS p 94-95

En Clar Systems somos especialistas en la fabricación y distribución de sistemas de higiene industrial. Con sede en la ciudad de Alicante, nacemos como una empresa familiar, fruto de la experiencia de más de 35 años en el sector de la higiene industrial.

Presentamos un catálogo con más de 200 referencias, un centro productivo en nuestra comarca y nuestros principales productores situados también en la provincia.

El fin último de nuestra empresa es la innovación en el más amplio sentido de la palabra. Para ello, procuramos siempre la mejora continua de nuestros procesos, con un profundo esmero en la fabricación de nuestros productos, en aras de la mejor calidad, adaptándonos a las nuevas necesidades del mercado y a las de nuestros clientes, con el objeto de lograr su mayor satisfacción. Tan importante es para nosotros como lo previamente mencionado, el ser una empresa sostenible y comprometida con el medio ambiente, procurando desde nuestras capacidades el más profundo respeto y la máxima protección a la naturaleza.

Clar Systems está presente en los principales certámenes nacionales e internacionales y progresivamente va adquiriendo mayor prospección en los mercados internacionales, con clientes que depositan su confianza en nosotros de más de 50 países de Europa, África y América. Nuestro logo es el fiel reflejo de los valores que nos identifican y distinguen, que están implícitos en cada uno de nuestros productos: experiencia, fabricación, fuerza y confianza. Los colores que éste presenta son símbolo de la innovación, la fiabilidad, la cercanía y la transparencia.

In Clar Systems we are specialists in the manufacture and distribution of industrial hygiene systems. Located in the city of Alicante, we were born as a family business, as a result of more than 35 years of experience in the industrial hygiene sector. We present a catalog with more than 200 references, a production center in our region as well as main suppliers also located in the province.

The ultimate goal of our company is innovation in the broadest sense of the word. To achieve this, we always strive for continuous improvement of our processes, with a deep care in the manufacture of our products, for the sake of the highest quality, adapting them to the new market requirements and those of our customers, in order to achieve their greatest satisfaction.

It is as important for us as the previously mentioned, to be a sustainable company and committed to the environment, seeking from our capabilities the deepest respect and maximum protection to nature.

Clar Systems is present in the main national and international events and is progressively acquiring greater prospección in international markets, with customers who place their trust in us from more than 50 countries in Europe, Africa and America. Our logo is a faithful reflection of the values that identify and distinguish us, which are implicit in each of our products: experience, manufacturing, strength and trust.

Its colors are a symbol of innovation, reliability, proximity and transparency.

FERIAS Y EXPOSICIONES FAIRS AND EXHIBITIONS

Clar Systems está presente en los principales certámenes nacionales e internacionales y progresivamente va adquiriendo mayor proyección en los mercados internacionales, con clientes que depositan su confianza en nosotros de más de 50 países de Europa, África y América.

Clar Systems is present in the main national and international competitions and is progressively acquiring greater prospects in international markets, with clients who place their trust in us from more than 50 countries in Europe, Africa and America.





AMPLIA RED DE DISTRIBUIDORES

Nuestra red de distribuidores especializados tiene una amplia presencia a nivel nacional e internacional.

Estamos presentes en los principales certámenes nacionales e internacionales.

EXPORTAMOS A MÁS DE 50 PAÍSES

El departamento de exportación gestionará los pedidos con rapidez y profesionalidad para que cada cliente sólo se preocupe de recibirlo.

WIDE NETWORK OF DISTRIBUTORS

Our network of specialized distributors has a wide presence at national and international level.

We are present in the main national and international competitions.

WE EXPORT TO MORE THAN 50 COUNTRIES

The export department will manage orders quickly and professionally so that each client only worries about receiving it.



Video del producto
Product Video



EXTRACCIÓN CENTRAL CENTER EXTRACTION

Moderno y elegante dispensador de papel higiénico con sistema de dispensación central. Fabricado en plástico ABS de alta calidad con aditivo antiestático para repeler el polvo. Fácil y rápida reposición del papel. Indicado para zonas de alta frecuencia de paso. Nuestra última incorporación para ayudar a mantener un ahorro constante de papel.

Modern and elegant paper dispenser hygienic with central dispensing system. Made of high quality ABS plastic with antistatic additive to repel dust. Easy and fast replacement of the paper. Indicated for areas of high frequency of passage. Our latest addition to help maintain a constant saving of paper.



EXTRACCIÓN CENTRAL CENTER EXTRACTION

novedad
new

Referencia

PC3000PB

Acabado/Finish

PB



Referencia

PC3000PN

Acabado/Finish

PN

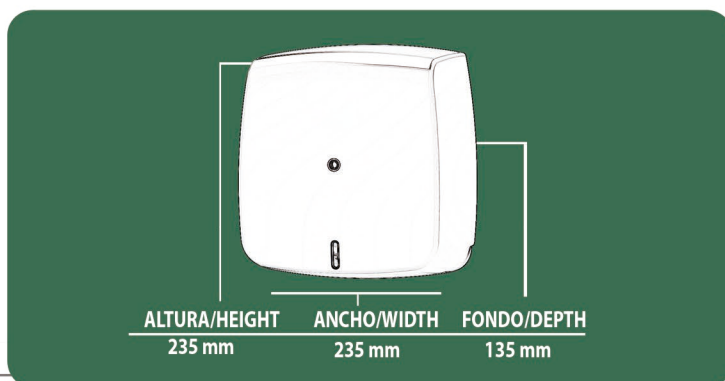

Referencia

PC3000PP

Acabado/Finish

PP



Referencia

PC3000PT

Acabado/Finish

PT



- Fabricado en plástico ABS antiestático.
- Capacidad para rollo de Ø200mm y eje de Ø45mm.
- Ancho de papel 115mm máximo.
- Ranura frontal para la visualización del contenido.
- Base trasera con ranuras para una fácil instalación.
- Sistema de cerradura con llave CLAR.
- Caja de 6 unidades.

- Made of antistatic ABS plastic.
- Capacity for Ø200mm roll and Ø45mm axis.
- Paper width 115mm maximum.
- Front slot for content display.
- Rear base with slots for easy installation.
- CLAR key lock system.
- Box of 6 units.



PAPELERA HIGIÉNICA FEMENINA

FEMALE TOILET BIN



Contenedor higiénico femenino fabricado en polipropileno eco-sostenible con carga mineral de alta resistencia y calidad.

Pedal para la rápida apertura de la tapa con trampilla oculta, en la cual se puede poner bolsa de enzimas para evitar los malos olores durante 4 semanas (recomendado). Recomendado para zonas de alta frecuencia de paso.

Feminine hygienic container manufactured in eco-sustainable polypropylene with mineral filler high strength and quality.

Pedal for quick opening of the lid with hidden hatch, in which you can put bag of enzymes to prevent bad smells for 4 weeks (recommended). Recommended for high frequency areas by the way.

PAPELERA HIGIÉNICA FEMENINA

FEMALE TOILET BIN



novedad
new

Referencia

PAC4010BG



Referencia

PAC4010ECONG



- Contenedor sanitario para depositar compresas sanitarias.
 - Fabricado en PP con carga mineral, de alta resistencia y calidad.
 - Tapa superior con apertura mediante pedal y extraíble para facilitar la limpieza.
 - Capacidad de 15l.
 - Posibilidad de instalación de eliminador de olores interno.
 - Recomendado para áreas de alta frecuencia de paso.
- Especial colectividades -Dimensiones(mm) : 578x364x183
- Sanitary container to deposit sanitary napkins.
 - Made of PP with mineral filler, high strength and quality.
 - Top lid with pedal opening and removable for easy cleaning.
 - Capacity of 15l.
 - Possibility of installing an internal odor eliminator.
 - Recommended for areas with high traffic frequency.
- Special collectivities -Dimensions (mm) : 578x364x183



novedad
new

- Bolsa de enzimas de 20grs en formato sólido para la eliminación de olores de los residuos higiénicos femeninos.
 - Agradable olor a cítricos.
 - Elimina los olores durante 4 semanas.
 - Presentación en bote de 12 uds.
- Bag of enzymes of 20grs in solid format for the elimination of odors from feminine hygiene waste.
 - Pleasant citrus scent.
 - Eliminates odors for 4 weeks.
 - Presentation in a jar of 12 units.



AUTOMÁTICO
SIN CONTACTO
NON-CONTACT
AUTOMATIC



SENSOR
ÓPTICO
OPTIC
SENSOR



Video del producto
Product Video



Espray / Spray



Bolsa / Bag



Rellenable / Refillable

DOSIFICADOR DE JABÓN AUTOMÁTICO AUTOMATIC SOAP DISPENSER

KYRA

Fabricados en ABS con aditivo antiestático
Made of ABS with Antistatic additive



Presentamos nuestra última y más distinguida apuesta por la tecnología y la calidad. Kyra es nuestro más reciente dispensador de jabón electrónico, especialmente diseñado para geles hidroalcohólicos en versión de cartucho y recargable.

Con él nos proponemos reducir el riesgo de infección por el COVID 19, deteniendo la transmisión de infecciones por medio de las manos.

We present our up-to-date and most distinguished and superb commitment to technology and quality. Kyra is our newest electronic soap dispenser, particularly designed for hydroalcoholic gels in cartridge versions and refillable. It is our endeavour to reduce the risk of infection by the COVID 19 by stopping the transmission of infections by means of the hands.

CLAR
systems

KYRA DOSIFICADOR DE JABÓN AUTOMÁTICO

AUTOMATIC SOAP DISPENSER ESPUMA/FOAM

novedad
new



Referencia

JE8090EPB



Acabado/Finish

PB

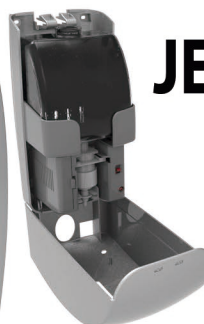

Referencia

JE8090EPP



Acabado/Finish

PP



Referencia

JE8090EPN



Acabado/Finish

PN

- Fabricado en plástico ABS antiestático para repeler el polvo.
- Depósito rellenable de 1 L.
- Ranura frontal para la visualización del contenido.
- Funciona con sensor óptico alimentado por 6 pilas AA-LR6.
- Disponibilidad de válvula de espuma o de gel.
- Sistema de cerradura con llave CLAR.
- Dosificación por dosis 0,4ml.
- Caja de 8 unidades.

- Made in antistatic ABS thermoplastic to repel dust.
- 1 liter refillable tank.
- Slot for content display.
- Works with optical sensor powered by 6 AA-LR6 Batteries.
- Availability of foam or gel valve.
- Lock with CLAR key.
- Dosage per dose 0,4ml.
- 8 units per box.

RECOMENDAMOS /WE RECOMMEND

Soporte con peana para dispensadores de jabón líquido
Support with base for liquid soap dispensers

SOPJ1191



Soporte con peana y dosificador automático KYRA
Support with base and automatic dispenser KYRA

LO ENCONTRARÁS EN LA
YOU WILL FIND IT IN
PAG.17

SOP8090LPB

SOP8090LPP

SOP8090LPN

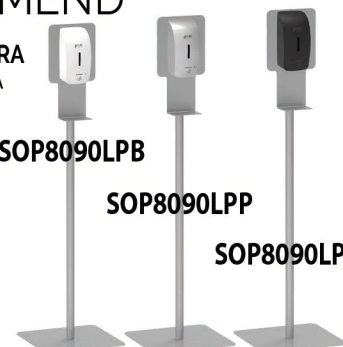

KYRA DOSIFICADOR DE JABÓN AUTOMÁTICO

AUTOMATIC SOAP DISPENSER LIQUIDO/LIQUID · ESPRAY/SPRAY

novedad
new



Referencia
JE8090LPB



Referencia **new**
JE8090SPB



Acabado/Finish
PB



Referencia
JE8090LPP



Referencia **new**
JE8090SPP



Acabado/Finish
PB



Referencia
JE8090LPN



Referencia **new**
JE8090SPN



Acabado/Finish
PN



- Salida en espray para gel hidroalcohólico **new**
- Fabricado en plástico ABS antiestático para repeler el polvo.
- Para uso de gel líquido o gel hidroalcohólico
- Depósito rellenable de 1 L.
- Ranura frontal para la visualización del contenido.
- Funciona con sensor óptico alimentado por 6 pilas AA-LR6.
- Disponibilidad de válvula de espuma o de gel.
- Sistema de cerradura con llave CLAR.
- Dosificación por dosis 0,4ml.
- Caja de 8 unidades.

- Spray outlet for hydroalcoholic gel **new**
- Made in antistatic ABS thermoplastic to repel dust.
- For use of liquid gel and hydroalcoholic gel.
- 1 liter refillable tank.
- Slot for content display.
- Works with optical sensor powered by 6 AA-LR6 Batteries.
- Availability of foam or gel valve.
- Lock with CLAR key.
- Dosage per dose 0,4ml.
- 8 units per box.

KYRA DOSIFICADOR DE JABÓN AUTOMÁTICO

AUTOMATIC SOAP DISPENSER CARTUCHO/CARTRIDGE

novedad
new



Acabado/Finish

PB

Referencia

JE8090CPB



Acabado/Finish

PP

Referencia

JE8090CPP



Acabado/Finish

PN

Referencia

JE8090CPN



- Fabricado en plástico ABS antiestático para repeler el polvo.
- Formato bolsa
- Capacidad: 0,9 L.
- Ranura frontal para la visualización del contenido.
- Compatible exclusivamente con nuestras referencias CJ8091, CJ8092 y CJ8093
- Sistema cautivo opcional (consultar condiciones)
- Sistema de cerradura con llave CLAR.
- Caja de 8 unidades.

- Made in antistatic ABS thermoplastic.
- Bag format
- Capacity: 0,9 L.
- Compatible exclusively with our ref. CJ8091, CJ8092 and CJ8093
- Works with optical sensor powered by 6 AA-LR6 Batteries.
- Optional captive bag system.
- Lock with CLAR key.
- 8 units per box.

RECOMENDAMOS /WE RECOMMEND

LO ENCONTRARÁS EN LA
YOU WILL FIND IT IN

PAG.15



CJ8091



CJ8092



CJ8093

KYRA DOSIFICADOR DE JABÓN AUTOMÁTICO AUTOMATIC SOAP DISPENSER



Referencia

CJ8091



Gel de manos en espuma con alto poder tensoactivo, cuyo PH neutro y ausencia de ingredientes agresivos en su formulación, proporcionan un cuidado especial a la piel.

Foaming hand gel with high surfactant power, whose neutral PH and absence of aggressive ingredients in its formulation, provide a special care to the skin.

0,4 ml / Puls. -Push



Referencia

CJ8092



Gel líquido para manos con alto poder tensoactivo cuyo PH neutro y ausencia de ingredientes agresivos en su formulación, proporcionan un cuidado especial a la piel.

Limpia, higieniza y perfuma las manos agradablemente

Liquid hand gel with high surfactant power whose neutral PH and absence of aggressive ingredients in their formulation, they provide special care to the skin. Cleans, sanitizes and pleasantly perfumes hands

0,4 ml / Puls. -Push



Referencia

CJ8093



Gel hidroalcohólico sanitizante con alto contenido en alcohol con lo que se consigue una rápida limpieza e higienización, dejando una agradable fragancia. No necesita agua ni enjuagues posteriores.

Hydroalcoholic sanitizing gel with a high content of alcohol with which a quick cleaning and sanitizing, leaving a pleasant fragrance. It does not need water or subsequent rinses.

0,4 ml / Puls. -Push

Compatibles exclusivamente con nuestra ref. JE8090C

Exclusively compatible with our ref. JE8090C

Bolsa de 900 ml
900 ml bag

6 unidades por caja
6 units per box

RECOMENDAMOS /WE RECOMMEND

Dosificador de jabón automático
Automatic soap dispensers



JE8090CPB



JE8090CPP



JE8090CPN

LO ENCONTRARÁS EN LA
YOU WILL FIND IT IN

PAG. 13



SOPORTES PARA DOSIFICADORES DE GEL

SUPPORT WITH BASE FOR LIQUID SOAP DISPENSER

Los soportes que presentamos son el complemento ideal para nuestros dispensadores de jabón. Permite colocar las jaboneras en cualquier lugar, dotándolas de una independencia que permite al cliente colocar la Kyra sin necesidad de una pared.

The supports that we present are the ideal complement for our soap dispensers. They allow the soap dispensers to be placed anywhere, giving them an independence that allows the customer to place the Kyra without the need of a wall.



KYRA SOPORTES PARA DOSIFICADORES DE GEL

SUPPORT WITH BASE FOR LIQUID SOAP DISPENSER



Referencia

SOPJ1191



Soporte con peana de 1 pieza para dispensadores de jabón.

Support with 1-piece base, for liquid soap dispensers.

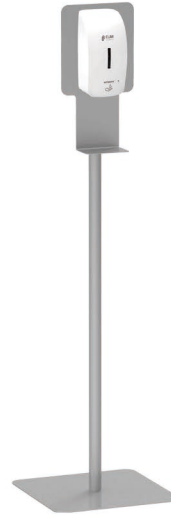

Referencia

SOP8090LPB



Soporte con dosificador automático rellenable KYRA.

Disponibile para gel líquido, gel en espuma y gel hidroalcohólico

Support with automatic refillable dispenser KYRA

Available for liquid gel, foam gel and hidroalcoholic gel.

- Soporte con peana de 1 pieza.
- Estructura fabricada en acero electrocincado de 2mm y la peana de 4mm de espesor y acabado en pintura poliéster color acero líquido.
- Bandeja para la recogida del jabon que evita el goteo al suelo.
- Base provista de tacos antideslizamiento.
- No requiere instalación.
- Compatible con nuestras referencias J1100COD - J9100COD y JE8090.

- Support with 1 piece base.
- Structure made of 2mm electrozincated steel and 4 mm thick base and finished in liquid steel color polyester paint.
- Tray for collecting soap wich prevents dripping onto the floor.
- Base provided with anti-slip studs.
- No installation required.
- For use with our references J1100COD J9100COD and JE8090.



Referencia

SOP8090LPP



Soporte con dosificador automático rellenable KYRA.

Disponibile para gel líquido, gel en espuma y gel hidroalcohólico

Support with automatic refillable dispenser KYRA

Available for liquid gel, foam gel and hidroalcoholic gel.



Referencia

SOP8090LPN



Soporte con dosificador automático rellenable KYRA.

Disponibile para gel líquido, gel en espuma y gel hidroalcohólico

Support with automatic refillable dispenser KYRA

Available for liquid gel, foam gel and hidroalcoholic gel.

RECOMENDAMOS /WE RECOMMEND

LO ENCONTRARÁS EN LA
YOU WILL FIND IT IN

PAG.13



JE8090

Dosificador de jabón automático
Automatic soap dispensers

LO ENCONTRARÁS EN LA
YOU WILL FIND IT IN

PAG.23



J9100COD J1100

Dispensador de jabón en formato bolsa
Soap dispensers in bag format



Video del producto

Product Video



Espray / Spray



Bolsa / Bag



Rellenable / Refillable

DOSIFICADORES DE JABÓN EN FORMATOS DE BOLSA Y RELLENABLES

SOAP DISPENSERS IN BAG AND REFILLABLE FORMATS

BELLA

Nuestra jabonera Bella tiene la posibilidad de funcionar con alcohol o jabón líquido y en espuma, tanto en formato rellenable, bolsa o espray si el cliente así lo desea.

Esto puede suceder gracias a este dosificador que presentamos a continuación que cuenta con un depósito rellenable.

Our Bella soap dish has the possibility to work with alcohol or liquid soap and foam, both in Refillable format as a bag or spray, if the customer so wishes. This can happen thanks to this dispenser that we present below that it has a deposit refillable.



 CLAR
systems

BELLA DISPENSADORES DE JABÓN RELLENABLE LÍQUIDO Y ESPRAY

LIQUID REFILLABLE SOAP AND SPRAY DISPENSERS

novedad
new



Referencia
J9100LPB



Referencia
J9100LPP



Referencia
J9100LPN



Referencia
J9100LPT



Referencia **J9100SPB** ^{new}



Referencia **J9100SPP** ^{new}



Referencia **J9100SPN** ^{new}



Referencia **J9100SPT** ^{new}



Acabado/Finish

PB

Acabado/Finish

PB

Acabado/Finish

PN

Acabado/Finish

PT

- Fabricado en ABS con aditivo antiestático para repeler el polvo y PEHD
- Recomendado para lavabos de alta frecuencia de paso.

- Made of ABS with antistatic additive to repel dust and PEHD.
- Recommended for high frequency washbasins

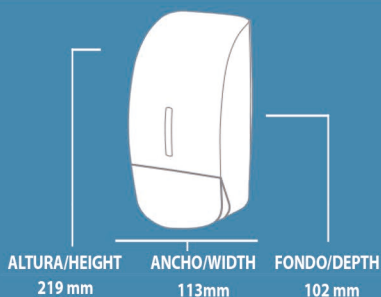

Capacidad
Capacity
(l)
0,90

Cantidad por pulsación
Quantity per pump
(ml)
0,65

- Salida en spray para loción alcohólica ^{new}
- Fabricado en ABS, con aditivo antiestático para repeler el polvo y PEHD
- Recomendado para lavabos con alta frecuencia de paso.

- Spray outlet for alcoholic lotion ^{new}
- Made of ABS with antistatic additive to repel dust and PEHD.
- Recommended for high frequency washbasins

BELLA DISPENSADORES DE JABÓN RELLENABLE EN ESPUMA

FOAM REFILLABLE SOAP DISPENSERS

novedad
new



Referencia

J9100EPB



Acabado/Finish

PB



Referencia

J9100EPP



Acabado/Finish

PP



- Para uso de gel en espuma
- Fabricado en ABS, con aditivo antiestático para repeler el polvo y PEHD
- Recomendado para lavabos con alta frecuencia de paso

- For foam gel use
- Made of ABS with antistatic additive to repel dust and PEHD.
- Recommended for high frequency washbasins



Referencia

J9100EPN



Acabado/Finish

PN



Referencia

J9100EPT



Acabado/Finish

PT

BELLA DISPENSADORES DE JABÓN EN FORMATO BOLSA SOAP DISPENSERS IN BAG FORMAT



Referencia
J9100PB



Acabado/Finish
PB



Referencia
J9100PP



Acabado/Finish
PP

- Fabricado en plástico ABS antiestático.
- Formato bolsa.
- Capacidad: 0,75 l.
- Ranura frontal para la visualización del contenido.
- Compatible exclusivamente con nuestra ref. CJ9100, CJ9200 y CJ9300
- Opción de jabón en gel con nuestra ref. CJ9200.
- Sistema cautivo opcional (consultar condiciones)
- Sistema de cerradura con llave CLAR
- Caja de 10 unidades.

· Made in antistatic ABS thermoplastic.

· Bag format.

· Capacity: 0,75 l.

· Compatible exclusively with our ref. CJ9100, CJ9200 and CJ9300

· Optional gel dispensation with our ref. CJ9200.

· Optional captive bag system.

· Lock with CLAR key.

· 10 units per box.



ALTURA/HEIGHT
219 mm

ANCHO/WIDTH
113 mm

FONDO/DEPTH
102 mm

Capacidad /Capacity **0,75**
(l)

Cantidad por pulsación / Quantity per pump
Espuma/Foam **0,4** (ml) Líquido/Liquid **0,65**



Referencia
J9100PN



Acabado/Finish
PN



Referencia
J9100PT



Acabado/Finish
PT

RECOMENDAMOS /WE RECOMMEND

LO ENCONTRARÁS EN LA
YOU WILL FIND IT IN

PAG.23



CJ9100



CJ9200



CJ9300

BELLA DOSIFICADOR DE JABÓN

SOAP DISPENSER



Referencia

CJ9100



Gel de manos en espuma con alto poder tensoactivo, cuyo PH neutro y ausencia de ingredientes agresivos en su formulación, proporcionan un cuidado especial a la piel.

Foaming hand gel with high surfactant power, whose neutral PH and absence of aggressive ingredients in its formulation, provide a special care to the skin.

0,4 ml. / puls. - push



Referencia

CJ9200



Gel líquido para manos con alto poder tensoactivo cuyo PH neutro y ausencia de ingredientes agresivos en su formulación, proporcionan un cuidado especial a la piel.

Limpia, higieniza y perfuma las manos agradablemente

Liquid hand gel with high surfactant power whose neutral PH and absence of aggressive ingredients in their formulation, they provide special care to the skin. Cleans, sanitizes and pleasantly perfumes hands

0,65 ml. / puls. - push



Referencia

CJ9300



Gel hidroalcohólico sanitizante con alto contenido en alcohol con lo que se consigue una rápida limpieza e higienización, dejando una agradable fragancia. No necesita agua ni enjuagues posteriores.

Hydroalcoholic sanitizing gel with a high content of alcohol with which a quick cleaning and sanitizing, leaving a pleasant fragrance. It does not need water or subsequent rinses.

0,65 ml. / puls. - push

Compatibles exclusivamente con nuestra ref. J9100

Exclusively compatible with our ref. JE9100

Opción de incorporar sistema cautivo(consultar condiciones)

Option to incorporate system captive (check conditions)

**Bolsa de 750 ml
750 ml bag**

**6 unidades por caja
6 units per box**

RECOMENDAMOS /WE RECOMMEND

Dispensadores de jabón en espuma
Foam soap dispensers



J9100PB



J9100PP



J9100PN



J9100PT

**LO ENCONTRARÁS EN LA
YOU WILL FIND IT IN**

PAG.19



Video del producto
Product Video



DISPENSADORES DE JABÓN
LIQUID SOAP DISPENSERS

I-NOVA

Fabricados en plástico ABS antiestático

Producto insignia de la marca Clar Systems. Primera jabonera de la marca con un diseño y prestaciones inigualables en su segmento. Es ideal para cualquier tipo de jabón, puede funcionar con la mayoría de los hidroalcoholes. Fabricada con los mejores materiales plásticos de primera calidad.

Flagship product of the Clar Systems brand. The brand's first soap dish with a design and performance unmatched in its segment. It is ideal for any type of soap, it can work with most hydroalcohols. Made with the best quality plastic materials.



 CLAR
systems

I-NOVA DISPENSADORES DE JABÓN

LIQUID SOAP DISPENSERS



Referencia
J1100PB
Acabado/Finish
PB



Referencia
J1100PP
Acabado/Finish
PP

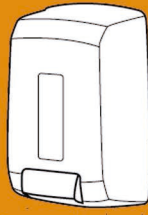

ALTURA/HEIGHT 219 mm
ANCHO/WIDTH 113 mm
FONDO/DEPTH 102 mm

Capacidad
Capacity
(l)
1,1

Dosificaciones
Dosages
(uds)
850

Cantidad por pulsación
Quantity per pump
(ml)
1,3

- Fabricado en plástico ABS antiestático.
- Depósito fabricado en plástico SAN
- Capacidad: 1,1 l.
- Soporta todo tipo de jabones.
- Ranura frontal para la visualización del contenido.
- Válvula antigoteo resistente a la corrosión.
- Sistema de cerradura con llave CLAR
- Caja de 12 unidades.

- Made in antistatic ABS thermoplastic.
- SAN thermoplastic tank
- Capacity: 1,1 l.
- Allow liquid soaps
- Corrosion resistant anti-drip valve.
- Slot at the front for viewing content level
- Lock with CLAR key.
- 12 units per box.



Referencia
J1100PN
Acabado/Finish
PN



Referencia
J1100PT
Acabado/Finish
PT

RECOMENDAMOS /WE RECOMMEND

Dispensador de papel en rollo
Toilet paper roll dispenser

LO ENCONTRARÁS EN LA
YOU WILL FIND IT IN

PAG.29



Dispensador de papel toalla
Foldel towel dispenser

LO ENCONTRARÁS EN LA
YOU WILL FIND IT IN

PAG.33



Dispensador de papel toalla
fluido céntrico
Center-pulltowel dispenser

LO ENCONTRARÁS EN LA
YOU WILL FIND IT IN

PAG.35





Video del producto
Product Video



DISPENSADORES DE JABÓN ACCIONAMIENTO MEDIANTE CODO ELBOW OPERATED SOAP DISPENSER



La última modificación aplicable a la Bella y a la I-Nova que Clar Systems ofrece al cliente es el sistema de accionamiento mediante codo. De esta manera proponemos un modelo de jabonera más higiénico al no tener que tocar con la mano. Esta nueva propuesta está diseñada y pensada para ambientes hospitalarios.

The last modification applicable to the Bella and the I-Nova that Clar Systems offers to the customer is the elbow drive system. In this way we propose a more hygienic soap dispenser model as it is not necessary to touch with the hand. This new proposal is designed and intended for hospital environments.

CLAR
systems

DISPENSADORES DE JABÓN ACCIONAMIENTO MEDIANTE CODO

ELBOW OPERATED SOAP DISPENSERS

Referencia
J1100PB-COD



Acabado/Finish
PB

Capacidad
Capacity
(l) **1,1**

Cantidad por pulsación
Quantity per pump
(ml) **1,2 - 1,3**

I-NOVA

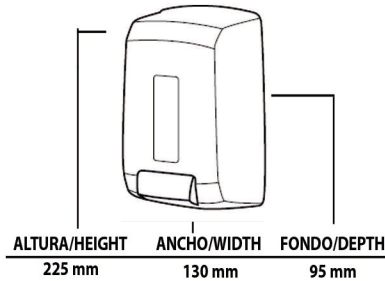

- Fabricado en plástico ABS antiestático.
 - Depósito fabricado en plástico SAN.
 - Capacidad: 1,1l.
 - Soporta todo tipo de jabones.
 - Ranura frontal para la visualización del contenido.
 - Válvula antigoteo resistente a la corrosión.
 - Sistema de cerradura con llave CLAR.
 - Caja de 12 unidades.
- Made in antistatic ABS thermoplastic.
 - SAN thermoplastic tank.
 - Capacity: 1,1l.
 - Allow liquid soaps.
 - Corrosion resistant anti-drip valve.
 - Slot at the front for viewing content level.
 - Lock with CLAR key.
 - 12 units per box

Referencia
J9100PB-COD



Acabado/Finish
PB

Capacidad
Capacity
(l) **0,75**

Cantidad por pulsación
Quantity per pump
(ml) **0,4**

BELLA

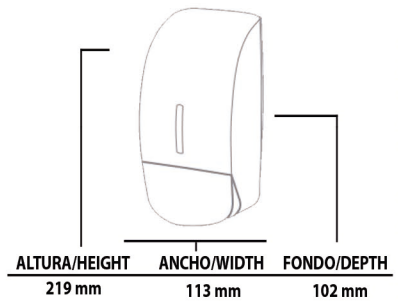

- Fabricado en plástico ABS antiestático.
 - Formato bolsa.
 - Capacidad: 0,75l.
 - Ranura frontal para la visualización del contenido.
 - Compatible exclusivamente con nuestra ref. CJ9100, CJ9200 Y CJ9300
 - Opción de jabón en gel con nuestra ref. CJ9200.
 - Sistema cautivo opcional (consultar condiciones).
 - Sistema de cerradura con llave CLAR.
 - Caja de 10 unidades
- Made in antistatic ABS thermoplastic.
 - Bag format
 - Capacity: 0,75 l.
 - Compatible exclusively with our ref. CJ9100, CJ9200 and CJ9300
 - Optional gel dispensation with our ref- CJ9200
 - Optional captive bag system.
 - Lock with CLAR key.
 - 10 units per box

Referencia
J9100LPB-COD



Acabado/Finish
PB

Capacidad
Capacity
(l) **0,90**

Cantidad por pulsación
Quantity per pump
(ml) **0,4**

BELLA

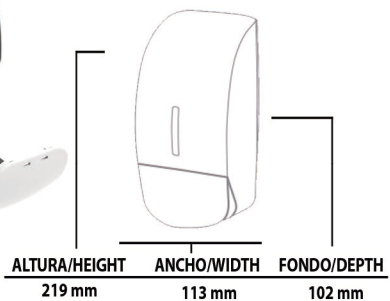

- Fabricado en plástico ABS antiestático para repeler el polvo.
 - Depósito rellenable de 900ml.
 - Para uso de gel líquido o gel hidroalcohólico y gel en espuma.
 - Ranura frontal para la visualización del contenido.
 - Disponibilidad de válvula de espuma o de gel.
 - Sistema de cerradura con llave CLAR
- Made in antistatic ABS thermoplastic to repel dust.
 - 900ml refillable tank.
 - For use of liquid gel and hydroalcoholic gel and hydroalcoholic gel.
 - Slot for content display.
 - Availability of foam or gel valve.
 - Lock with CLAR key.

RECOMENDAMOS /WE RECOMMEND

LO ENCONTRARÁS EN LA
YOU WILL FIND IT IN

PAG.17

Soporte con peana para dispensadores
de jabón líquido
Support with base for liquid soap dispensers

SOPJ1191

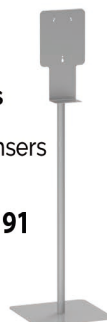

*Disponibile en otros acabados



Video del producto
Product Video



DISPENSADORES DE PAPEL EN ROLLO
TOILET PAPER ROLL DISPENSERS

PORTARROLLOS I-NOVA

SERIE
P3000



Moderno diseño, elegante y resistente.

El dispensador de papel higiénico es un aparato resistente elegante y funcional.

Fácil y rápido de reponer el rollo en su interior con su sistema de cierre por clip.

Puede contener adaptadores para distintos ejes de papel

Modern design, elegant and resistant.

The toilet paper dispenser is a sturdy, elegant and functional appliance.

Quick and easy to replace the roll inside with its clip closure system.

May contain adapters for different paper spindles

CLAR
systems

I-NOVA DISPENSADORES DE PAPEL EN ROLLO TOILET PAPER ROLL DISPENSERS



Referencia
P3000PB
Acabado/Finish
PB



Referencia
P3000PP
Acabado/Finish
PP

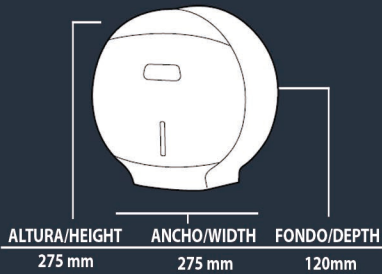

Capacidad Papel
Paper Roll Capacity
(mm)
Ø230

Diámetro de Eje
Paper Roll Core
(mm)
Ø45 -60⁽¹⁾-72⁽¹⁾

- Fabricado en plástico ABS antiestático.
- Capacidad para rollo de Ø230mm y eje de Ø45mm.
- Ranura frontal para la visualización del contenido.
- Base trasera con ranuras para una fácil instalación.
- Adaptadores opcionales para ejes de Ø60⁽¹⁾ o Ø72⁽¹⁾ mm.
- Sistema de cerradura con llave CLAR.
- Caja de 6 unidades.

(1) Diámetro de eje bajo pedido.

- Made in antistatic ABS thermoplastic.
- Ø230mm paper roll diameter and Ø45mm paper roll core.
- Slot at the front for viewing content level.
- Back-plate with multiple slots for easy installation.
- Ø60mm or Ø72mm optional shaft adapters⁽¹⁾
- Lock with CLAR key
- 6 units per box

(1) Paper roll core on request



Referencia
P3000PN
Acabado/Finish
PN



Referencia
P3000PT
Acabado/Finish
PT

RECOMENDAMOS /WE RECOMMEND

Dosificador de jabón
Soap dispensers

LO ENCONTRARÁS EN LA
YOU WILL FIND IT IN
PAG.27



J1100

Dispensador de papel toalla
Folded towel dispenser

LO ENCONTRARÁS EN LA
YOU WILL FIND IT IN
PAG.33



T6100

Dosificador de papel
fluido céntrico
Centric fluid paper
dispenser

LO ENCONTRARÁS EN LA
YOU WILL FIND IT IN
PAG.35



M1100

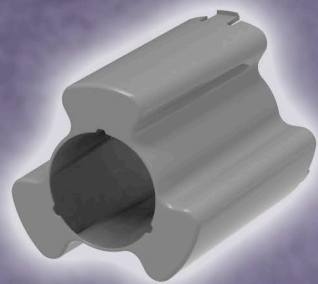

 **CLAR**
systems



Video del producto
Product Video



DISPENSADORES DE PAPEL EN ROLLO
TOILET PAPER ROLL DISPENSERS

PORTARROLLOS I-NOVA

SERIE
P4000



El mayor de los portarrollos Innova. Moderno diseño, elegante, robusto y resistente, especialmente diseñado para mercados exteriores.

El dispensador de papel higiénico es un aparato resistente, elegante y funcional.

Fácil y rápido de reponer el rollo en su interior con su sistema de cierre por clip.

Puede contener adaptadores para distintos ejes de papel.

The largest of the Innova roll holders. Modern, elegant, robust and resistant design, specially designed for foreign markets.

The toilet paper dispenser is a sturdy, elegant and functional appliance.

Quick and easy to replace the roll inside with its clip closure system.

May contain adapters for different paper spindles.

 **CLAR**
systems

I-NOVA DISPENSADORES DE PAPEL EN ROLLO TOILET PAPER ROLL DISPENSERS



Referencia
P4000PB
Acabado/Finish
PB



Referencia
P4000PP
Acabado/Finish
PP

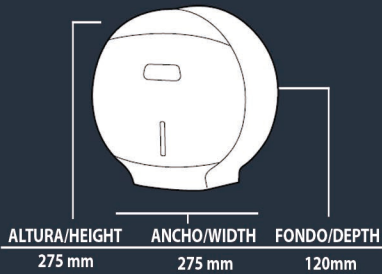

Capacidad Papel
Paper Roll Capacity
(mm)
Ø270

Diámetro de Eje
Paper Roll Core
(mm)
Ø60-72⁽¹⁾

- Fabricado en plástico ABS antiestático.
- Capacidad para rollo de Ø270mm y eje de Ø60mm.
- Ranura frontal para la visualización del contenido.
- Base trasera con ranuras para una fácil instalación.
- Adaptador opcional para eje Ø72⁽¹⁾mm.
- Sistema de cerradura con llave CLAR.
- Caja de 1 unidad.

(1) Diámetro de eje bajo pedido.

- Made in antistatic ABS thermoplastic.
- Ø270mm paper roll diameter and Ø60mm paper roll core.
- Slot at the front for viewing content level.
- Back-plate with multiple slots for easy installation.
- Ø72 mm optional shaft adapters⁽¹⁾
- Lock with CLAR key
- 1 units per box

(1) Paper roll core on request



Referencia
P4000PN
Acabado/Finish
PN



Referencia
P4000PT
Acabado/Finish
PT

RECOMENDAMOS /WE RECOMMEND

Dosificador de jabón
Soap dispensers

LO ENCONTRARÁS EN LA
YOU WILL FIND IT IN
PAG.25



J1100

Dispensador de papel toalla
Folded towel dispenser

LO ENCONTRARÁS EN LA
YOU WILL FIND IT IN
PAG.33



T6100

Dispensador de papel toalla
fluido céntrico
Center-pull towel dispenser

LO ENCONTRARÁS EN LA
YOU WILL FIND IT IN
PAG.35



M1100



CLAR
systems

DISPENSADORES DE PAPEL TOALLA
FOLDED TOWEL DISPENSERS

TOALLEROS
I-NOVA



Video del producto
Product Video



El dispensador de papel toalla es un aparato resistente, elegante y funcional.

Diseñado para todo tipo de formatos de toalla "Z", "C" y "W".
Fácil y rápido de reponer el rollo en su interior con su sistema de cierre por clip.

The paper towel dispenser is a sturdy, elegant and functional device.

*Designed for all kinds of towel formats "Z", "C" and "W".
Quick and easy to replace the roll inside with its clip closure system.*

CLAR
systems

I-NOVA DISPENSADORES DE PAPEL TOALLA FOLDED TOWEL DISPENSERS



Referencia
T6100PB
Acabado/Finish
PB



Referencia
T6100PP
Acabado/Finish
PP

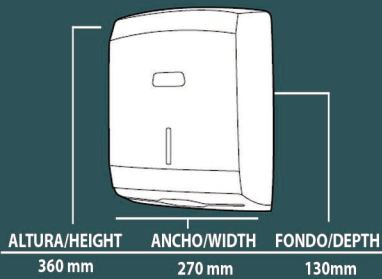

Capacidad Toallas
Towels Capacity
(uds)
600

Tamaño Toalla
Towel Size
(mm)
240x100

- Fabricado en plástico ABS antiestático.
- Capacidad para 600 toallas.
- Tamaño max. de toalla 240x100mm.
- Base trasera con ranuras para una fácil instalación.
- Salida del papel que previene el bloqueo.
- Ranura frontal para la visualización del contenido.
- Sistema de cerradura con llave CLAR.
- Caja de 6 unidades.

- Made in antistatic ABS thermoplastic.
- 600 towels capacity folded in C/Z.
- Towels size max. 240x100mm.
- Back-plate with multiple slots for easy installation.
- Paper outlet prevent the paper from blocked.
- Slot at the front for viewing content level.
- Lock system with CLAR key.
- 6 units per box.



Referencia
T6100PN
Acabado/Finish
PN



Referencia
T6100PT
Acabado/Finish
PT

RECOMENDAMOS /WE RECOMMEND

Dosificador de jabón
Soap dispensers

LO ENCONTRARÁS EN LA
YOU WILL FIND IT IN
PAG.25



J1100

Dispensador de papel
en rollo
Toilet paper roll dispenser

LO ENCONTRARÁS EN LA
YOU WILL FIND IT IN
PAG.29



P3000

Dispensador de papel
toalla fluido céntrico
Center-pulltowel dispenser

LO ENCONTRARÁS EN LA
YOU WILL FIND IT IN
PAG.35



M1100



Video del producto
Product Video



DISPENSADORES DE PAPEL FLUIDO CÉNTRICO CENTER-PULLTOWEL DISPENSERS

I-NOVA

El dispensador de papel fluido céntrico (tipo mecha) es un aparato moderno, elegante y funcional.

Fácil instalación, y rápida instalación de la bobina.
Recomendado para zonas de alto frecuencia de uso

The central fluid paper dispenser (wick type) it is a modern, elegant and functional appliance. Easy installation, and quick installation of the coil. Recommended for areas of high frequency of use



CLAR
systems

I-NOVA DISPENSADORES DE PAPEL TOALLA FLUIDO CÉNTRICO CENTER-PULLTOWEL DISPENSERS



Referencia
M1100PB
Acabado/Finish
PB



Referencia
M1100PP
Acabado/Finish
PP

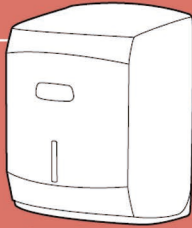

ALTURA/HEIGHT 334 mm ANCHO/WIDTH 226 mm FONDO/DEPTH 230mm

Diámetro Papel
Roll Paper
(mm)
Ø210

Altura Papel
Paper Height
(mm)
240

- Fabricado en plástico ABS antiestático.
- Capacidad para un rollo de Ø210x240 mm.
- Sistema fijo de corte de papel.
- Base trasera con ranuras para una fácil instalación.
- Ranura frontal para la visualización del contenido.
- Sistema de cerradura con llave CLAR.
- Caja de 6 unidades.

- Made in antistatic ABS thermoplastic.
- Ø210x240 mm roll dimension.
- Fixed cutting system.
- Back-plate with multiple slots for easy installation.
- Slot at the front for viewing content level.
- Lock system with CLAR key.
- 6 units per box.



Referencia
M1100PN
Acabado/Finish
PN



Referencia
M1100PT
Acabado/Finish
PT

RECOMENDAMOS /WE RECOMMEND

Dosificador de jabón
Soap dispensers

LO ENCONTRARÁS EN LA
YOU WILL FIND IT IN
PAG.25



J1100

Dispensador de papel
en rollo

Toilet paper roll dispenser
LO ENCONTRARÁS EN LA
YOU WILL FIND IT IN
PAG.29



P3000

Dispensador de papel toalla
Folded towel dispenser

LO ENCONTRARÁS EN LA
YOU WILL FIND IT IN
PAG.33



T6100



DISPENSADORES DE JABÓN LIQUID SOAP DISPENSERS

TRENDY

Jabonera robusta, de diseño elegante.
Es ideal para cualquier tipo de jabón. Puede funcionar
con la mayoría de hidroalcoholes.
Fabricada con los mejores materiales plásticos de
primera calidad

*Robust soap dish with elegant design.
It is ideal for any type of soap.
It can work with most hydroalcohols.
Made with the best quality plastic materials*



TRENDY DISPENSADORES DE JABÓN

LIQUID SOAP DISPENSERS



Referencia
J1800PG

Acabado/Finish
PB

Capacidad / Capacity
0,8 l.
Dosificaciones / Dosages
620 uds.
Cantidad por pulsación
Quantity per pump
1,3 ml.



Referencia
J1800PP

Acabado/Finish
PP

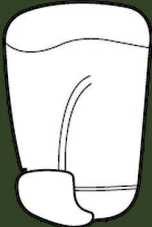

ALTURA/HEIGHT 200 mm ANCHO/WIDTH 100 mm FONDO/DEPTH 110 mm

- Fabricado en plástico ABS antiestático.
- Depósito fabricado en plástico SAN.
- Capacidad :0,8 l,
- Soporta todo tipo de jabones.
- Ranura frontal para visualización del contenido.
- Válvula antigoteo resistente a la corrosión.
- Sistema de cerradura con llave CLAR.
- Unidades por caja : 10

- Made in antistatic ABS thermoplastic.
- SAN thermoplastic tank.
- Capacity: 0,8 l.
- Allow liquid soaps.
- Corrosion resistant anti-drip valve.
- Slot at the front for viewing content level.
- Lock with CLAR key.
- Units per box: 10



Referencia
J1500PG

Acabado/Finish
PB

Capacidad / Capacity
1,5 l.
Dosificaciones / Dosages
1.150 uds.
Cantidad por pulsación
Quantity per pump
1,3 ml.



Referencia
J1500PP

Acabado/Finish
PP

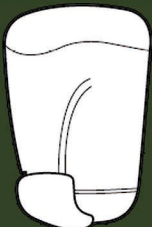

ALTURA/HEIGHT 256 mm ANCHO/WIDTH 133 mm FONDO/DEPTH 128 mm

- Fabricado en plástico ABS antiestático.
- Depósito fabricado en plástico SAN.
- Capacidad : 1,5 l.
- Soporta todo tipo de jabones.
- Ranura frontal para visualización del contenido.
- Válvula antigoteo resistente a la corrosión.
- Sistema de cerradura con llave CLAR.
- Unidades por caja : 8

- Made in antistatic ABS thermoplastic.
- SAN thermoplastic tank.
- Capacity: 1,5 l.
- Allow liquid soaps.
- Corrosion resistant anti-drip valve.
- Slot at the front for viewing content level.
- Lock with CLAR key.
- Units per box: 8

RECOMENDAMOS / WE RECOMMEND

Dispensador de papel en rollo
Toilet paper roll dispenser

LO ENCONTRARÁS EN LA
YOU WILL FIND IT IN
PAG.39



P3500

Dispensador de papel toalla
Folded towel dispenser

LO ENCONTRARÁS EN LA
YOU WILL FIND IT IN
PAG.41



T6500

Dispensador de papel fluido
céntrico
Center pull towel dispenser

LO ENCONTRARÁS EN LA
YOU WILL FIND IT IN
PAG.43



M1500



DISPENSADORES DE PAPEL EN ROLLO

TOILET PAPER ROLL DISPENSERS

TRENDY



Robusto y elegante gama de dispensadores de papel higiénico industrial en rollo.

Fabricada con los mejores materiales plásticos de primera calidad.

Indicado para lavabos de alta frecuencia de paso.

Robust and elegant range of dispensers roll industrial toilet paper.

Made with the best plastic materials from first quality.

Indicated for high frequency washbasins,

 **CLAR**
systems

TRENDY DISPENSADORES DE PAPEL EN ROLLO TOILET PAPER ROLL DISPENSERS



Referencia
P3500PG

Acabado/Finish
PB

Capacidad Papel
Paper Roll Capacity

Ø240 mm.

Diametro Eje
Paper Roll Core

Ø45 mm.



Referencia
P3500PP

Acabado/Finish

PP

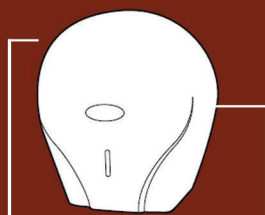

ALTURA/HEIGHT ANCHO/WIDTH FONDO/DEPTH
285 mm 265 mm 132 mm

- Fabricado en plástico ABS antiestático.
- Capacidad para rollo de Ø240 mm y eje de Ø45mm.
- Ranura frontal para la visualización del contenido.
- Sistema de cerradura con llave CLAR.
- Caja de 8 unidades.

- Made in antistatic ABS thermoplastic.
- Ø240mm paper roll diameter and Ø45 mm paper roll core.
- Slot at the front for viewing content level.
- Lock with CLAR key.
- 8 units per box.



Referencia
P4500PG

Acabado/Finish
PB

Capacidad Papel
Paper Roll Capacity

Ø285 mm.

Diametro Eje
Paper Roll Core

Ø60 mm.



Referencia
P4500PP

Acabado/Finish

PP

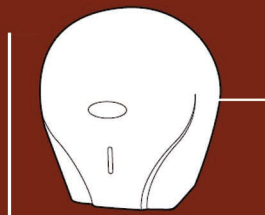

ALTURA/HEIGHT ANCHO/WIDTH FONDO/DEPTH
330 mm 310 mm 140 mm

- Fabricado en plástico ABS antiestático.
- Capacidad para rollo de Ø285 mm y eje de Ø60mm.
- Ranura frontal para la visualización del contenido.
- Sistema de cerradura con llave CLAR.
- Caja de 1 unidad.

- Made in antistatic ABS thermoplastic.
- Ø285mm paper roll diameter and Ø60 mm paper roll core.
- Slot at the front for viewing content level.
- Lock with CLAR key.
- 1 unit per box.

RECOMENDAMOS / WE RECOMMEND

Dosificador de jabón
Soap dispensers

LO ENCONTRARÁS EN LA
YOU WILL FIND IT IN
PAG.37



J1500

Dispensador de papel toalla
Folded towel dispenser

LO ENCONTRARÁS EN LA
YOU WILL FIND IT IN
PAG.41



T6500

Dispensador de papel fluido
céntrico
Center-pulltowel dispenser

LO ENCONTRARÁS EN LA
YOU WILL FIND IT IN
PAG.43



M1500



DISPENSADORES DE PAPEL TOALLA

FOLDED TOWEL DISPENSERS

TRENDY



Robusto y elegante dispensador de toallas tipo "Z", "C" y "W".

Fabricado con los mejores materiales plásticos de primera calidad.

Fácil y rápida reposición de las toallas.

Sturdy and elegant type towel dispenser "Z", "C" and "W".

Made with the best plastic materials from first quality.

Quick and easy replacement of towels.

 **CLAR**
systems

TRENDY DISPENSADORES DE PAPEL TOALLA FOLDED TOWEL DISPENSERS



Referencia
T6500PG



Acabado/Finish
PB



Referencia
T6500PP



Acabado/Finish
PP

- Fabricado en plástico ABS antiestático.
- Capacidad para 600 toallas.
- Tamaño max. de toalla 250x100 mm.
- Salida del papel que previene el bloqueo.
- Ranura frontal para la visualización del contenido.
- Incluye sistema de cerradura con llave CLAR.
- Caja de 1 unidad.

- Made in antistatic ABS thermoplastic.
- 600 towels capacity folded in C/Z.
- Towels size max. 250 x 100 mm.
- Slot at the front for viewing content level.
- Paper outlet prevent the paper from blocked.
- Lock with CLAR key.
- 1 unit per box.

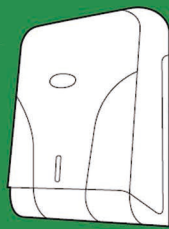

ALTURA/HEIGHT 365 mm
ANCHO/WIDTH 275 mm
FONDO/DEPTH 120 mm

Capacidad Toallas
Towels Capacity
(uds)

600

Tamaño Toalla
Towel Size
(mm)

250 x 100

RECOMENDAMOS /WE RECOMMEND

Dosificador de jabón
Soap dispensers

LO ENCONTRARÁS EN LA
YOU WILL FIND IT IN
PAG.37



J1500

Dispensador de papel
en rollo
Toilet paper roll dispenser

LO ENCONTRARÁS EN LA
YOU WILL FIND IT IN

PAG.39



P3500

Dispensador de papel fluido
céntrico
Center-pulltowel dispenser

LO ENCONTRARÁS EN LA
YOU WILL FIND IT IN

PAG.43



M1500



DISPENSADORES DE PAPEL FLUIDO CÉNTRICO

CENTER-PULLTOWEL DISPENSER

TRENDY



Robusto y elegante dispensador de papel fluido céntrico (tipo mecha).

Fabricado con los mejores materiales plásticos de primera calidad.

Fácil y rápida reposición de la bobina.

Indicado para zonas de alta frecuencia de uso.

Robust and elegant fluid paper dispenser centric (wick type).



Made with the best plastic materials first quality.

Quick and easy reel replacement.

Indicated for areas of high frequency of use.



 CLAR
systems

TRENDY DISPENSADORES DE PAPEL FLUIDO CENTRÍCO CENTER-PULLTOWEL DISPENSER





Referencia
M1500PG
Acabado/Finish
PB

Diámetro Papel
Roll Paper
Ø230 mm.
Altura Papel
Paper Height
220 mm.

Referencia
M1500PP
Acabado/Finish
PP



ALTURA/HEIGHT
370 mm

ANCHO/WIDTH
255 mm

FONDO/DEPTH
260 mm

- Fabricado en plástico ABS antiestático.
- Capacidad para un rollo de Ø230 x 220 mm.
- Sistema fijo de corte de papel.
- Sistema de cerradura con llave CLAR.
- Caja de 1 unidad.

- Made in antistatic ABS thermoplastic.
- Ø230 x 220 mm roll dimension.
- Fixed cutting system.
- Lock system with CLAR key.
- 1 unit per box





Referencia
M1300PG
Acabado/Finish
PB

Diámetro Papel
Roll Paper
Ø210 mm.
Altura Papel
Paper Height
240 mm.

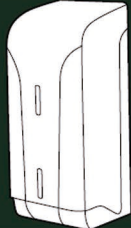

Referencia
M1300PP
Acabado/Finish
PP



ALTURA/HEIGHT
330 mm

ANCHO/WIDTH
135 mm

FONDO/DEPTH
145 mm

- Fabricado en plástico ABS antiestático.
- Capacidad para un rollo de Ø120 x 240 mm.
- Sistema fijo de corte de papel.
- Ranura frontal para la visualización del contenido.
- Sistema de cerradura con llave CLAR.
- Caja de 10 unidades.

- Made in antistatic ABS thermoplastic.
- Ø120 x 240 mm roll dimension.
- Fixed cutting system.
- Slot at the front for viewing content level.
- Lock system with CLAR key.
- 10 units per box.

RECOMENDAMOS /WE RECOMMEND

Dosificador de jabón
Soap dispensers

LO ENCONTRARÁS EN LA
YOU WILL FIND IT IN
PAG.37



Dispensador de papel toalla
Folded towel dispenser

LO ENCONTRARÁS EN LA
YOU WILL FIND IT IN
PAG.41



Dispensador de papel en rollo
Toilet paper roll dispenser

LO ENCONTRARÁS EN LA
YOU WILL FIND IT IN
PAG.39





DISPENSADORES DE PAPEL HIGIÉNICO "Z"

BULL PACK TOILET

TISSUE DISPENSERS

TRENDY



Robusto y elegante dispensador de papel higiénico en formato "Z".

Fabricado con los mejores materiales plásticos de primera calidad.

Fácil y rápida reposición del papel.

Indicado para zonas de alta frecuencia de uso.

Robust and elegant toilet paper dispenser in "Z" format.



Made with the best plastic materials from first quality.

Quick and easy paper replacement.

Indicated for areas of high frequency of use.





TRENDY DISPENSADORES DE PAPEL HIGIÉNICO "Z" BULL PACK TOILET TISSUE DISPENSERS





Referencia
P1300PG
Acabado/Finish
PB

Capacidad Toallas
Towels Capacity
600 uds.
Tamaño Toalla
Towel Size
120 x 100 mm.

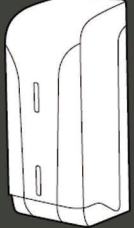

Referencia
P1300PP
Acabado/Finish
PP



ALTURA/HEIGHT: 330 mm
ANCHO/WIDTH: 135 mm
FONDO/DEPTH: 145 mm



- Fabricado en plástico ABS antiestático.
- Salida del papel que previene el bloqueo.
- Ranura frontal para la visualización del contenido.
- Sistema de cerradura con llave CLAR.
- Caja de 10 unidades

- Made in antistatic ABS thermoplastic.
- Slot at the front for viewing content level.
- Paper outlet prevent the paper from blocked.
- Lock with CLAR key.
- 10 units per box.





Referencia
P1000PG
Acabado/Finish
PB

Capacidad Toallas
Towels Capacity
200 uds.
Tamaño Toalla
Towel Size
120 x 100 mm.

Referencia
P1000PP
Acabado/Finish
PP

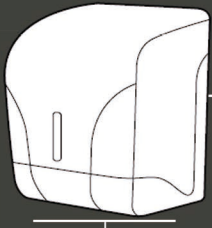

ALTURA/HEIGHT: 175 mm
ANCHO/WIDTH: 135 mm
FONDO/DEPTH: 145 mm

- Fabricado en plástico ABS antiestático.
- Salida del papel que previene el bloqueo.
- Ranura frontal para la visualización del contenido.
- Sistema de cerradura con llave CLAR.
- Caja de 10 unidades

- Made in antistatic ABS thermoplastic.
- Slot at the front for viewing content level.
- Paper outlet prevent the paper from blocked.
- Lock with CLAR key.
- 10 units per box.

RECOMENDAMOS /WE RECOMMEND

Dosificador de jabón
Soap dispensers

LO ENCONTRARÁS EN LA
YOU WILL FIND IT IN
PAG.37



J1500

Dispensador de papel toalla
Folded towel dispenser

LO ENCONTRARÁS EN LA
YOU WILL FIND IT IN
PAG.41



T6500

Dispensador de papel en rollo
Toilet paper roll dispenser

LO ENCONTRARÁS EN LA
YOU WILL FIND IT IN
PAG.39



P3500



**DISPENSADORES DE PAPEL
AUTOCORTANTE
MANUAL HARD ROLL
TOWEL DISPENSER**

KYRA



Distinguido y actual dispensador de papel en rollo autocortante.

Fabricado en ABS con aditivo antiestático para repeler el polvo.

Mando lateral para asegurar la dispensación del papel.

Indicado para zonas de alta frecuencia de paso.

Distinguished and current roll paper dispenser self-cutting.

Made of ABS with antistatic additive for repel dust.

Side control to ensure dispensing of the paper.

Indicated for high frequency areas.

CLAR
systems

KYRA

DISPENSADOR DE PAPEL AUTOCORTANTE AUTOCUT PAPER TOWEL DISPENSER

Referencia

TA6000PB

Acabado/Finish

PB



Acabado/Finish

PT



Referencia

TA6000PT



Referencia

TA6000PP

Acabado/Finish

PP



Acabado/Finish

PN



Referencia

TA6000PN



Diámetro Papel
Roll Paper
(mm)

Ø 210 máx.



ALTURA/HEIGHT 355 mm ANCHO/WIDTH 305 mm FONDO/DEPTH 240 mm

Largo servicio papel
Paper roll width
(mm)

210 máx.

- Dispensador de papel bobina continuo autocortante, tipo superficie.
- Fabricado en ABS, con aditivo "Antiestático" para repeler el polvo.
- Dispensación a conveniencia, mediante mecanismo de precorte de accionamiento manual.
- Cuchilla interior de precorte totalmente protegida y sin acceso exterior.
- Mando lateral para asegurar la dispensación de papel.
- Recarga de papel rápida y sencilla.
- Visor frontal de gran formato, para visualización de contenido.
- Cierre con cerradura y llave de seguridad.
- Recomendado para lavabos de alta frecuencia de paso.
- Especial colectividades.

Self-cutting continuous roll paper dispenser, surface type.

• Made of ABS, with "Antistatic" additive for repel dust.

Convenience dispensing, through a mechanism manually operated precut.

Fully protected inner precut blade without exterior access.

• Side control to ensure paper dispensing.

• Quick and easy paper reloading.

Large format front viewer for viewing content.

• Closing with lock and security key.

• Recommended for high frequency washbasins.

Special collectivities.



DISPENSADORES PALANCA DE PAPEL BOBINA Y AUTOMÁTICO

LEVER DISPENSERS
OF PAPER ROLL AND AUTOMATIC

TRENDY

Elegante y funcional dispensador de papel bobina continuo palanca y automático

Admite cualquier calidad y eje de papel.

Fabricado con ABS antiestático para repeler el polvo.

Indicado para zonas de alta frecuencia de paso.

Elegant and functional roll paper dispenser continuous lever. and automatic

It admits any quality and axis of paper.

Made with antistatic ABS to repel dust.

Indicated for high frequency areas.

TRENDY DISPENSADOR DE PAPEL PALANCA LEVER PAPER DISPENSER

Referencia

TP6000PG



Acabado/Finish

PB



Referencia

TP6000PT



Acabado/Finish

PT



- Fabricado en plástico ABS antiestático.
- Capacidad para un rollo de Ø220 x 210 mm.
- Mecanismo de palanca de accionamiento manual.
- Sistema fijo de corte de papel.
- Sistema de cerradura con llave CLAR.
- Caja de 1 unidad.

- Made in antistatic ABS thermoplastic.
- Ø220 x 210 mm roll dimension.
- Manual lever paper system.
- Fixed cutting system.
- Lock system with CLAR key.
- 1 unit per box.

Diámetro Papel / Roll Paper Ø 220
(mm)

Altura Papel/ Paper Height 230
(mm)

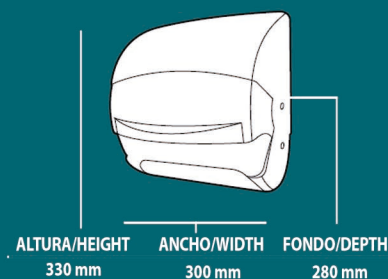



DISPENSADOR DE SERVILLETAS

NAPKIN DISPENSER

LUBBO



Elegante y sencillo dispensador de servilletas con clip porta cartas.
Fabricado en ABS con aditivo antiestático para repeler el polvo.
Alojamiento para láminas publicitarias.
Recomendado para zonas de alta frecuencia de uso.

*Elegant and simple napkin dispenser with card holder clip.
Made of ABS with antistatic additive for repel dust.
Accommodation for advertising sheets.
Recommended for high frequency areas of use.*



LUBBO

DISPENSADOR DE SERVILLETAS NAPKIN DISPENSER



Referencia

KN0100



Acabado/Finish

PN

Acabado/Finish

PB

Acabado/Finish

PG



- Fabricado en ABS antiestático.
- Tapa negra y base transparente fumé.
- Cierre de la tapa mediante clips laterales.
- Alojamiento para láminas publicitarias.
- Clip portamenú.
- Capacidad para 200 servilletas tipo Z.
- Caja de 20 unidades.

- Made in antistatic ABS thermoplastic.
- Black cover and base clear smoked.
- Lock with side clips.
- Lateral seats for advertising.
- Menu holder.
- 200 napkins capacity folded in Z.
- 20 units per box.



ALTURA/HEIGHT 150 mm
ANCHO/WIDTH 135 mm
FONDO/DEPTH 150 mm

Capacidad
Capacity
(uds)

200

Papel
Paper
(mm)

100 x 200



DISPENSADORES DE BOBINA INDUSTRIAL

INDUSTRIAL ROLL DISPENSERS

AUNIA



Nuestros dispensadores de bobina, están especialmente diseñados para ámbitos de trabajo industrial. Son ideales para exteriores, principalmente para talleres, gasolineras, cocinas, etc.

Our coil dispensers are specially designed for industrial work environments. They are ideal for outdoors, mainly for workshops, gas stations, kitchens, etc.

AUNIA DISPENSADORES DE BOBINA INDUSTRIAL INDUSTRIAL ROLL DISPENSERS



Referencia

PB0300T

Acabado/Finish

PG

CAJA DE 1 UNIDAD.
1 UNIT PER BOX.



ALTURA/HEIGHT 860 mm
ANCHO/WIDTH 405 mm
FONDO/DEPTH 490 mm

Capacidad Papel
Paper Capacity
(mm)

Ø300 x 260

Diámetro Eje
Core Diameter
(mm)

Ø70



Referencia

PB0300S

Acabado/Finish

PG

CAJA DE 1 UNIDAD.
1 UNIT PER BOX.



ALTURA/HEIGHT 511 mm
ANCHO/WIDTH 405 mm
FONDO/DEPTH 196 mm



Referencia

PB0300M

Acabado/Finish

PG

CAJA DE 1 UNIDAD.
1 UNIT PER BOX.

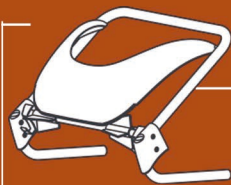

ALTURA/HEIGHT 340 mm
ANCHO/WIDTH 405 mm
FONDO/DEPTH 260 mm

- Fabricados en tubo de acero de Ø20 mm con recubrimiento en pintura epoxi y componentes en plástico ABS.
- Capacidades para rollo industrial de Ø300 x 260 y eje de Ø70 mm.

- Steel tube frame 20 mm coated with epoxi and parts in ABS plastic.
- Paper roll diameter Ø300 x 260 mm and Ø70 mm. paper roll core.



Video del producto
Product Video



M4100



P4300



T4600



J4110

DISPENSADORES EN ACERO INOX

STAINLESS STEEL DISPENSERS

INNEX



Fabricados en una pieza en acero inoxidable AISI-304.
Base trasera con múltiples ranuras para una fácil instalación.

Ranura frontal para la visualización del nivel del contenido

Acabados en brillo o satinado

Sistema de cerradura con llave CLAR

Mades in AISI-304 stainless steel
seamless one-piece lid.

Bright or satin finish

Back-Plate with multiple slots for
easy installation.

Slot at the front for viewing content level

Lock system with CLAR key



INNEX DISPENSADORES EN ACERO INOX STAINLESS STEEL DISPENSERS

Referencia

T4600

Acabado/Finish



Referencia

M4100

Acabado/Finish

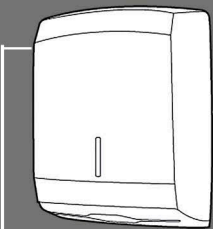

ALTURA/HEIGHT 340 mm
ANCHO/WIDTH 235 mm
FONDO/DEPTH 135 mm

- Capacidad para 600 toallas (max. 240 x 100 mm) "Z", "C" y "W"
- Diseño de salida de papel que previene el bloqueo.
- Caja de 6 unidades.
 - 600 Towels capacity folded in (size max. 240 x 100 mm.) "Z", "C" y "W"
 - Design of the paper outlet prevent the paper from blocked
 - 6 units per box.

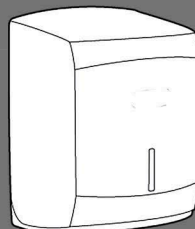

ALTURA/HEIGHT ? mm
ANCHO/WIDTH ? mm
FONDO/DEPTH ? mm

- Capacidad para un rollo de Ø210 x Ø210mm
- Sistema fijo de corte de papel
- Caja de 6 unidades
- *Solamente acabado en satinado
 - Ø210 x Ø210mm roll dimension
 - Fixed cutting system
 - 6 units per box.

* Only satin finish

Referencia

P4300

Acabado/Finish



Referencia

J4110

Acabado/Finish

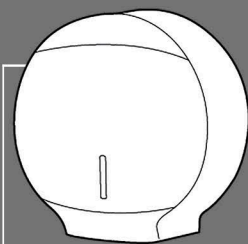

ALTURA/HEIGHT 275 mm
ANCHO/WIDTH 275 mm
FONDO/DEPTH 125 mm

- Capacidad para rollo de Ø250mm y eje de Ø45mm.
- Adaptadores opcionales para ejes de rollo de papel de Ø60 o Ø72 mm.
- Caja de 6 unidades
 - Ø250 mm paper roll diameter and Ø45 mm paper roll core
 - Ø60 mm or Ø72 mm optional shaft adapters
 - 6 units per box.

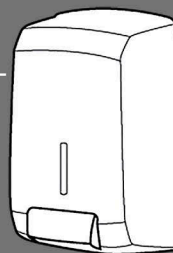

ALTURA/HEIGHT 220 mm
ANCHO/WIDTH 130 mm
FONDO/DEPTH 100 mm

- Depósito fabricado en plástico SAN.
- Capacidad: 1,1l.
- Soporta todo tipo de jabones.
- Válvula antigoteo resistente a la corrosión.
- Caja de 12 unidades..
 - SAN thermoplastic tank.
 - Capacity: 1,1l.
 - Allow liquid soaps.
 - Corrosion resistant anti-drip valve.
 - 12 units per box



DISPENSADORES EN ACERO INOX STAINLESS STEEL DISPENSERS

ECO

Nuestra línea de dispensadores más clásica, fabricada en Acero inox, cubriendo con ella todas las necesidades del cuarto de baño.
Indicada para baños de alta frecuencia de paso.

*Our most classic line of dispensers, manufactured in stainless steel, covering with it all the bathroom needs.
Indicated for high frequency baths.*

ECO

DISPENSADORES EN ACERO INOX STAINLESS STEEL DISPENSERS



Referencia

T4301

Acabado/Finish

BR



SA



Referencia

P4200

Acabado/Finish

BR



SA

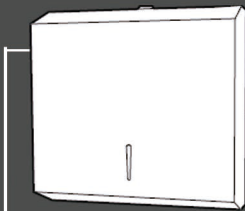

- Fabricado en acero inoxidable AISI-201.
- Capacidad para 400 toallas
- Tamaño max. de toalla 240x100mm.
- Ranura frontal para la visualización del contenido
- Sistema de cerradura con llave
- Caja de 10 unidades.

- Made in AISI-201 stainless one-piece body
- 400 towels capacity folded in C/Z
- Towels size max. 240 x 100 mm.
- Slot at the front for viewing content level
- Lock system with key
- 10 units per box

ALTURA/HEIGHT ANCHO/WIDTH FONDO/DEPTH
235 mm 340 mm 135 mm

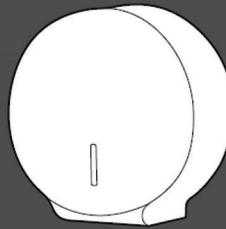

- Fabricado en acero inoxidable AISI-430
- Capacidad para rollo de Ø 250 mm. y eje de Ø 45mm.
- Base trasera con ranuras para una fácil instalación.
- Adaptadores opcionales para ejes de Ø 60 o Ø 72 mm.^(1,2)
- Ranura frontal para la visualización del contenido
- Sistema de cerradura con llave CLAR

- Made in AISI-430
- Ø 250mm paper roll diameter and Ø45 mm paper roll core
- Back-plate with multiple slots for easy installation
- Ø60mm or Ø72 mm optional shaft adapters (2)
- Slot at the front for viewing content level.
- Lock with CLAR key

ALTURA/HEIGHT ANCHO/WIDTH FONDO/DEPTH
275 mm 275 mm 125 mm

Referencia

J4050AI

Acabado/Finish

BR



- Fabricado en una pieza en acero inoxidable AISI-304.
- Capacidad 0,5 L. · 550 dosificaciones
- Soporta todo tipo de jabones
- Valvula antigoteo resistente a la corrosión
- Visor frontal para la visualización del contenido
- Sistema de cerradura con llave
- Caja de 50 unidades.

- Made in AISI-304 stainless seamless one-piece body
- Capacity 0.5 L. · 550 Dosages
- Allow liquid soaps
- Corrosion resistant anti-drip valve
- Slot at the front for viewing content level
- Lock system with key
- 50 units per box

ALTURA/HEIGHT ANCHO/WIDTH FONDO/DEPTH
155 mm 100 mm 57 mm

Referencia

J4080AI

Acabado/Finish

BR



- Fabricado en una pieza en acero inoxidable AISI-304.
- Capacidad 0,8L. · 550 dosificaciones
- Soporta todo tipo de jabones
- Valvula antigoteo resistente a la corrosión
- Visor frontal para la visualización del contenido
- Sistema de cerradura con llave
- Caja de 40 unidades.

- Made in AISI-304 stainless seamless one-piece body
- Capacity 0.8 L. · 550 Dosages
- Allow liquid soaps
- Corrosion resistant anti-drip valve
- Slot at the front for viewing content level
- Lock system with key
- 40 units per box

ALTURA/HEIGHT ANCHO/WIDTH FONDO/DEPTH
178 mm 115 mm 57 mm



SECADORES DE MANO HAND DRYERS

JET DRY

Compacto y elegante secador de manos con bajo nivel sonoro (62 dBA) y con un secado de manos en solo 7 segundos.

Filtro HEPA incorporado y depósito de agua. Recomendado para zonas de alta frecuencia de paso.

Compact and sleek bass drummer sound level (62 dBA) and with a drying of hands in just 7 seconds.

Built-in HEPA filter and water tank. Recommended for high frequency areas

JET DRY SECADORES DE MANO HAND DRYERS



Referencia
S5000PB

Acabado/Finish
PB



- Fabricado en plástico ABS y PA.
- Filtro HEPA.
- Depósito de agua.
- Interruptor para desconexión de la resistencia calefactora.
- Presión sonora 72-82dBA.
- Selector de 2 velocidades.
- Tiempo de secado 7 segundos.
- Temperatura del aire 20°C.
- Temporización 30 segundos.
- Tensión: 230V-60Hz.
- Certificación CE.
- Caja de 1 unidad.

- Made in ABS & PA thermoplastic.
- HEPA filter.
- Water storage tank.
- Disconnect switch the heating element.
- Sound pressure 72-82dBA.
- Two speeds selection.
- Drying time 7 seconds.
- Air temperature 20°C.
- Automatic disconnection in 30seconds.
- Voltage 230V-60Hz.
- CE approval
- 1 unit per box



Referencia
S5000PP

Acabado/Finish
PP

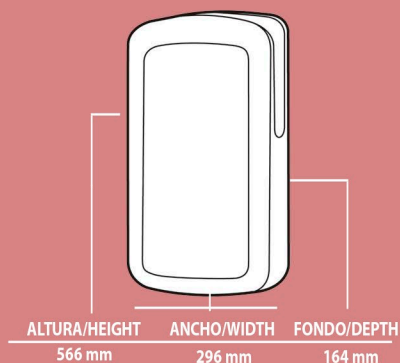

Potencia Rated Power (W)	Consumo Power Consumption (A)	Velocidad Aire Air Velocity (m/s)
1100/2000	11	95
Indice Protección Protection Level	Aislamiento Térmico Electrical Insulation	
IPX4	Class I	



SECADORES DE MANO HAND DRYERS

ULTRA DRY

Línea de secadores en acero inox AISI 304 para cubrir cualquier necesidad en los aseos. Dos opciones a elegir. Alta velocidad con secado rápido y ahorro de energía, y el tradicional de tobera. Indicado para zonas de alta frecuencia de paso.

Line of dryers in stainless steel AISI 304 for cover any need in the toilets. Two options to choose from. High speed with drying fast and energy saving, and the traditional nozzle. Indicated for high frequency areas

ULTRA DRY SECADORES DE MANOS HAND DRYERS



Referencia
S4000BR



Acabado/Finish

BR



Referencia
S4000SA



Acabado/Finish

SA

- Fabricado de una pieza en acero inoxidable AISI-304 y plástico PA.
- Filtro antipolvo.
- Interruptor para desconexión de la resistencia calefactora.
- Presión sonora 83dBA.
- Tiempo de secado 12s.
- Caudal 124m³/h
- Temperatura del aire 45° C.
- Temporización 60 segundos.
- Tensión 230V-60Hz
- Certificación CE
- Caja de 4 unidades

- Made in stainless steel AISI-304 seamless one-piece lid and PA plastic
- Anti-dust filter.
- Disconnect switch the heating element
- Sound pressure 83 dBA
- Drying time 12 seconds
- Effective airflow 124m³/h
- Air temperature 45° C
- Automatic disconnection in 60 seconds
- Voltage 230V-60Hz
- CE approval
- 4 units per box

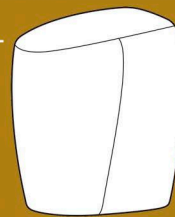

ALTURA/HEIGHT	ANCHO/WIDTH	FONDO/DEPTH
185 mm	268 mm	205 mm

Potencia Rated Power (W)	Consumo Power Consumption (A)	Velocidad Aire Air Velocity (m/s)
1200	5,5	63

Indice Protección Protection Level	Aislamiento Térmico Electrical Insulation
IPX1	Class I

IPX1

Class I



Referencia
S4100BR



Acabado/Finish

BR



Referencia
S4100SA



Acabado/Finish

SA

- Fabricado de una pieza en acero inoxidable AISI-304 y plástico PA.
- Tiempo de secado 25 segundos
- Caudal 248m³/h
- Presión sonora 65dBA
- Temperatura del aire 45°C
- Temporización 60 segundos
- Tensión 230V-60 Hz
- Certificación CE
- Caja de 4 unidades

- Made in stainless steel AISI-304 seamless one-piece lid and PA plastic
- Drying time 25 seconds
- Effective airflow 248m³/h
- Sound pressure 65 dBA
- Air Temperature 45°C
- Automatic disconnection in 60 seconds
- Voltage 230V-60Hz
- CE approval
- 4 units per box

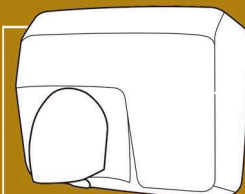

ALTURA/HEIGHT	ANCHO/WIDTH	FONDO/DEPTH
275 mm	230 mm	200 mm

Potencia Rated Power (W)	Consumo Power Consumption (A)	Velocidad Aire Air Velocity (m/s)
2300	9,5	27

Indice Protección Protection Level	Aislamiento Térmico Electrical Insulation
IPX1	Class I

IPX1

Class I



Referencia
S4200BR



Acabado/Finish

BR



Referencia
S4200SA



Acabado/Finish

SA

- Fabricado de una pieza en acero inoxidable AISI-304 y plástico PA.
- Tiempo de secado 7 segundos
- Caudal 69m³/h
- Presión sonora 85dBA
- Temperatura del aire 45°C
- Temporización 60 segundos
- Tensión 230V-60 Hz
- Certificación CE
- Caja de 4 unidades

- Made in stainless steel AISI-304 seamless one-piece lid and PA plastic
- Drying time 7 seconds
- Effective airflow 69m³/h
- Sound pressure 85 dBA
- Air Temperature 45°C
- Automatic disconnection in 60 seconds
- Voltage 230V-60Hz
- CE approval
- 4 units per box

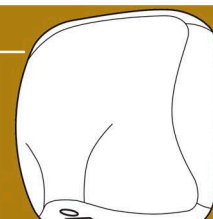

ALTURA/HEIGHT	ANCHO/WIDTH	FONDO/DEPTH
265 mm	270 mm	171 mm

Potencia Rated Power (W)	Consumo Power Consumption (A)	Velocidad Aire Air Velocity (m/s)
1200	5,5	90

Indice Protección Protection Level	Aislamiento Térmico Electrical Insulation
IPX1	Class I

IPX1

Class I



SECADORES DE MANO HAND DRYERS

FAST DRY

Fast Dry es nuestra gama de secadores de manos de alta velocidad en versión ABS.

Con bajo consumo de energía y rápido secado de manos en sólo 10 segundos.

Indicado para zonas de alta frecuencia de paso.

Fast Dry is our range of hand dryers high-speed in ABS version.

With low energy consumption and fast drying of hands in just 10 seconds.

Indicated for high frequency areas.

FAST DRY

SECADORES DE MANOS HAND DRYERS



Referencia
S1000PB



Acabado/Finish

PB



Referencia
S1000PP



Acabado/Finish

PP



Referencia
S1000PN



Acabado/Finish

PN

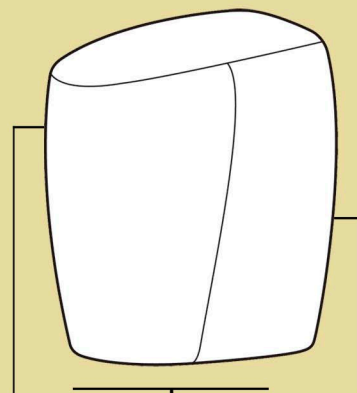

ALTURA/HEIGHT	ANCHO/WIDTH	FONDO/DEPTH
185 mm	268 mm	205 mm

Potencia Rated Power (W)	Consumo Power Consumption (A)	Velocidad Aire Air Velocity (m/s)
1200	5,5	63

Indice Protección
Protection Level

Aislamiento Térmico
Electrical Insulation

IPX1

Class II

- Fabricados en plástico ABS y PA
- Filtro antipolvo
- Interruptor para desconexión de la resistencia calefactora
- Tiempo de secado 12 segundos
- Caudal 124m³/h
- Presión sonora 83dBA
- Temperatura del aire 45°C
- Temporización 60 segundos
- Tensión 230V-60 Hz
- Certificación CE
- Caja de 4 unidades

- Made in ABS & PA thermoplastic.
- Anti-dust filter
- Disconnect switch the heating element
- Drying time 12 seconds
- Effective airflow 124m³/h
- Sound pressure 83 dBA
- Air Temperature 45°C
- Automatic disconnection in 60 seconds
- Voltage 230V-60Hz
- CE approval
- 4 units per box



CLAR
systems

SECADORES DE MANO **HAND DRYERS**

TRENDY

Nuestra gama de secadores más tradicionales,
económicos y básicos.
Diseño compacto con sistema de accionamiento por
sensor óptico.
Fabricado en ABS

*Our range of more traditional dryers, economic
and basic.
Compact design with drive system by optical sensor.
Made of ABS*

CLAR
systems

TRENDY

SECADORES DE MANOS HAND DRYERS

Referencia
S1100PB

Acabado/Finish
PB



Acabado/Finish

PP



Referencia

S1100PP

- Fabricado en plástico PV-ABSV0
- Tiempo de secado 30 s.
- Caudal 250m³/h
- Tensión 230V-60Hz
- Certificación CE
- Caja de 5 unidades

- Made in PC-ABSV0 thermoplastic
- Drying time 30 s.
- Effective airflow 250m³/h
- Voltage 230V-60Hz
- CE approval
- 5 units per box

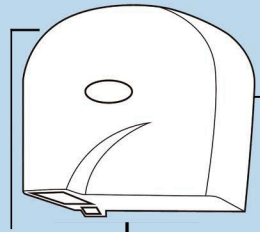

ALTURA/HEIGHT 250 mm ANCHO/WIDTH 275 mm FONDO/DEPTH 130 mm

Potencia
Rated Power
(W)

1690

Velocidad Aire
Air Velocity
(m/s)

20

Consumo
Power Consumption
(A)

7

Aislamiento Térmico
Electrical Insulation

Class II

Indice Protección
Protection Level

IP23

Acabado/Finish

PB

Referencia

S2000PB



- Fabricado en plástico ABS
- Tiempo de secado 30 s.
- Caudal 20m³/h
- Tensión 230V-60Hz
- Presión sonora 70dBA
- Certificación CE
- Caja de 6 unidades

- Made in ABS plastic
- Drying time 30 s.
- Effective airflow 20m³/h
- Voltage 230V-60Hz
- Sound pressure 70dBA
- CE approval
- 6 units per box

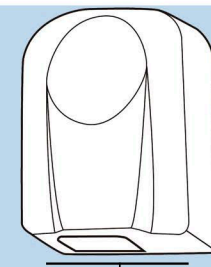

ALTURA/HEIGHT 282 mm ANCHO/WIDTH 225 mm FONDO/DEPTH 160 mm

Potencia
Rated Power
(W)

1650

Velocidad Aire
Air Velocity
(m/s)

20

Consumo
Power Consumption
(A)

7

Aislamiento Térmico
Electrical Insulation

Class II

Indice Protección
Protection Level

IPX1



SECADORES DE PELO HAIR DRYERS

PROFESSIONAL

Secadores de pelo compactos y modernos para instalación en pared, con toma de enchufe para máquina de afeitar incorporada.
Boton ON/OFF de seguridad.
Indicados para el uso en hoteles, residencias, etc.

*Compact and modern hair dryers for wall installation, with plug socket for built-in shaver.
Security ON / OFF button.
Indicated for use in hotels, residences, etc.*

PROFESSIONAL SECADORES DE PELO HAIR DRYERS



Referencia
SP1100PB

Acabado/Finish

PB



Referencia
SP1100PN

Acabado/Finish

PN

Referencia
SP1000PB

Acabado/Finish

PB



Referencia

SP1000PN

Acabado/Finish

PN



Dimensiones /Dimensions
(mm)

110 x 245 x 140

- Fabricado en plástico ABS
- Selector de 2 velocidades
- Pulsador ON/OFF de seguridad
- Enchufe para maquina de afeitar
- Interruptor de desconexión de la corriente
- Tensión 230V-60Hz
- Potencia total 1600W
- Certificación CE
- Índice de protección IPX1
- Aislamiento térmico clase II
- Dimensiones (mm) 153x210x91
- Caja de 20 unidades
- Made in ABS plastic.
- Speed selector with 2 settings
- On/Off safety push button
- Socket for shaver
- Power cut- off switch
- Voltage 230V-60Hz
- Rated power 1600W
- Power consumption 7A
- CE approval
- Protection level IPX1
- Electrical insulation class II
- Dimensions (mm) 153x210x91
- 20 units per box

- Fabricado en plástico ABS antiestático.
- Selector de 2 velocidades
- Pulsador de aire frío
- Enchufe para máquina de afeitar
- Interruptor de desconexión de la corriente
- Tobera para estilismo
- Tensión 230V-60Hz
- Potencia total 1600W
- Consumo 7A
- Índice de protección IPX1
- Aislamiento térmico clase II
- Made in antistatic ABS
- Speed selector with 2 settings
- Cool air shot
- Socket for shaver
- Power cut-off switch
- Hair-styling nozzle
- Voltage 230V-60Hz
- Rated power 1600W
- Power consumption 7A
- CE approval
- Protection level IPX1
- Electrical insulation class

Referencia
SP3000PG

novedad
new

Acabado/Finish

PG



Dimensiones /Dimensions
(mm)

280 x 250 x 80



- Fabricado en plástico ABS grafito.
- Selector de 3 velocidades de potencia.
- Selector de 3 temperaturas.
- Pulsador de aire frío.
- Pulsador de seguridad en el mango.
- Incluye bolsa negra para guardar.
- Tobera para estilismo
- Tensión 220-240V
- 50-60Hz
- Potencia total 2300W
- Consumo 10A
- Índice de protección IP00
- Aislamiento térmico clase II
- Made in antistatic ABS
- Speed selector with 3 settings
- Selector of 3 temperatures.
- Cool air button.
- Safety button on the handle.
- Hair-styling nozzle
- Includes black storage bag.
- Hair-styling nozzle
- Voltage 230V-60Hz
- Rated power 1600W
- Power consumption 7A
- CE approval
- Protection level IPX1
- Electrical insulation class

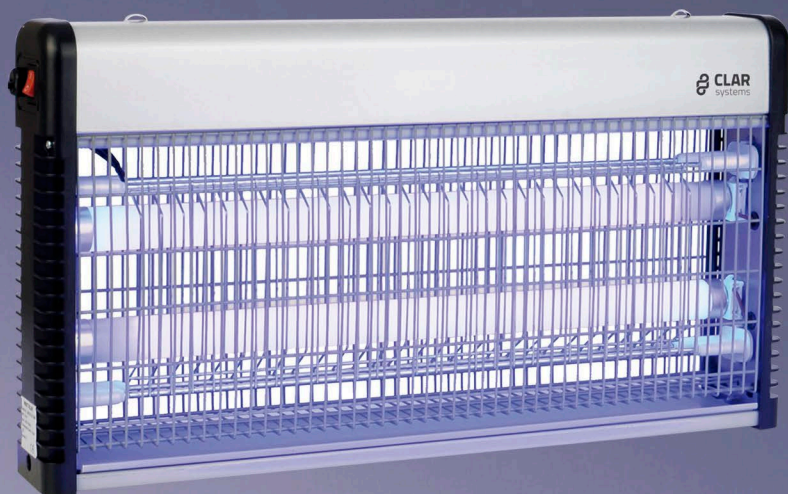

ELIMINADORES DE INSECTOS INSECT KILLERS

ELECTRONIC

Eliminadores de insectos electrónicos clásicos.
Diseño innovador ultra-fino que asegura una
amplia cobertura y una elevada eficacia.
Bandeja extraíble para una fácil limpieza.
Instalación de sobremesa o suspendido.

*Classic electronic insect eliminators.
Innovative ultra-thin design that ensures wide
coverage and high efficiency.
Removable tray for easy cleaning.
Desktop or suspended installation.*

ELECTRONIC ELIMINADORES DE INSECTOS

ELECTRONIC INSECT KILLERS

Referencia

PE0208E

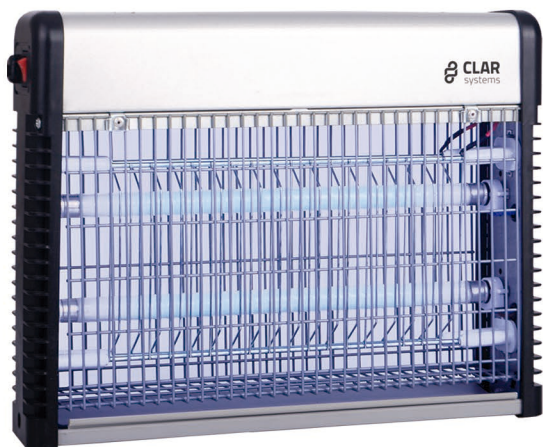

- Fabricado en aluminio y ABS
 - Área de acción 50 m²
 - Instalación suspendida o sobremesa
 - 2 lámparas G8 T5BL F8W
 - Tensión 230V-60Hz
 - Tensión en rejilla 2200V-7mA
 - Consumo 20W
 - Certificación CE
 - Índice de protección IP20
 - Aislamiento eléctrico clase I
 - Dimensiones (mm) 340x270x90
 - Caja de 6 unidades
- Made in aluminium alloy and ABS
 - Cell suspending or free-standing installation
 - Effective area 50 m²
 - 2 lamps G8 T5BL F8W
 - Voltage 230V-60Hz
 - Power grill voltage 2200V-7mA
 - Power consumption 20W
 - CE approval
 - Protection level IP20
 - Electrical insulation clas I
 - Dimensions (mm) 340x270x90
 - 6 units per box.

Referencia

PE0215E

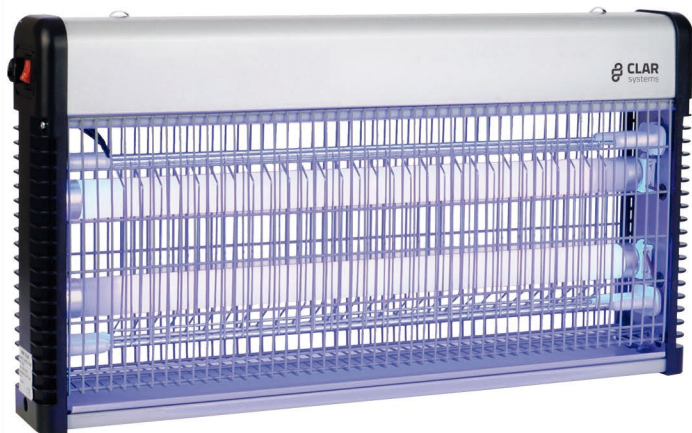

- Fabricado en aluminio y ABS
 - Área de acción 100 m²
 - Instalación suspendida o sobremesa
 - 2 lámparas G8 T5BL F8W
 - Tensión 230V-60Hz
 - Tensión en rejilla 2200V-7mA
 - Consumo 33W
 - Certificación CE
 - Índice de protección IP20
 - Aislamiento eléctrico clase I
 - Dimensiones (mm) 490x320x99
 - Caja de 6 unidades
- Made in aluminium alloy and ABS
 - Cell suspending or free-standing installation
 - Effective area 100 m²
 - 2 lamps G8 T5BL F8W
 - Voltage 230V-60Hz
 - Power grill voltage 2200V-7mA
 - Power consumption 33W
 - CE approval
 - Protection level IP20
 - Electrical insulation clas I
 - Dimensions (mm) 490x320x99
 - 6 units per box.



ELIMINADORES DE INSECTOS

INSECT KILLERS

GLUE BOARD

Nuestra gama de eliminadores de insectos, más avanzada e innovadora mediante adhesivo. Provisto de lámina adhesiva de fácil sustitución, libre de sustancias tóxicas o perjudiciales para la salud y el medio ambiente.

Funcionamiento más limpio y silencioso. Varios acabados y coberturas.

Our range of insect killers, more advanced and innovative by means of adhesive. Provided with an adhesive sheet for easy replacement, free of substances that are toxic or harmful to health and environment.

Cleaner and quieter operation. Various finishes and covers.

GLUE BOARD ELIMINADORES DE INSECTOS INSECT KILLERS

Referencia

PA0111E

Acabado/Finish



- Fabricado en plástico ABS
- Área de acción 50m²
- Sobremesa
- 1 lámpara E27 13W
- Tensión 230V-60Hz
- Consumo 13W
- Certificación CE
- Índice de protección IP20
- Aislamiento eléctrico clase I
- Dimensiones (mm) 280x320x120
- Caja de 10 unidades
- Made in ABS plastic
- Effective area 50m²
- 1 lamp E27 13W
- Voltage 230V-60Hz
- Power consumption 13W
- CE approval
- Protection level IP20
- Electrical insulation class I
- Dimensions (mm) 280x320x120
- 10 units per box



Referencia

PA0115E

Acabado/Finish



- Fabricado en plástico ABS
- Área de acción 50m²
- Instalación mural
- 1 lámpara E27 13W
- Consumo 13W
- Tensión 230V-60Hz
- Certificación CE
- Índice de protección IP20
- Aislamiento eléctrico clase I
- Dimensiones (mm) 400x240x200
- Caja de 8 unidades
- Made in ABS plastic
- Effective area 50m²
- 1 lamp E27 13W
- Voltage 230V-60Hz
- Power consumption 13W
- CE approval
- Protection level IP20
- Electrical insulation class I
- Dimensions (mm) 400x240x200
- 8 units per box

GLUE BOARD ELIMINADORES DE INSECTOS INSECT KILLERS

Referencia

PA0117E

Acabado/Finish



- Fabricado en aluminio
- Área de acción 50m²
- Instalación sobremesa o mural
- 1 lámpara E27 13W
- Consumo 13W
- Tensión 230V-60Hz
- Certificación CE
- Índice de protección IP20
- Aislamiento eléctrico clase I
- Dimensiones (mm) 245x120x305
- Caja de 6 unidades

- Made in aluminum
- Effective area 50m²
- Wall mounting or free-standing installation
- 1 lamp E27 13W
- Voltage 230V-60Hz
- Power consumption 13W
- CE approval
- Protection level IP20
- Electrical insulation class I
- Dimensions (mm) 400x240x200
- 6 units per box



Referencia

PA0218E



- Fabricado en acero inoxidable AISI-304 (acabado satinado)
- Área de acción 150 m²
- Instalación suspendida
- 2 lámparas G8 T5BL F8W
- Tensión 230V-60Hz
- Consumo 40W
- Certificación CE
- Índice de protección IP20
- Aislamiento eléctrico clase I
- Dimensiones (mm) 675x350x180
- Caja de 4 unidades

- Made in stainless steel AISI-304 (Satin finish)
- Cell suspending installation
- Effective area 150 m²
- 2 lamps G8 T5BL F8W
- Voltage 230V-60Hz
- Power grill voltage 2200V-7mA
- Dimensions (mm) 675x350x180
- Power consumption 40W
- CE approval
- Protection level IP20
- Electrical insulation class I
- 4 units per box.

LÁMINAS ADHESIVAS GLUE BOARDS

LÁMINAS ADHESIVAS BLUE BOARDS



Referencia
AD0111E

Repuesto parrilla
Spare part insect killer
(ref.)
PA0111E

Packs por caja
Packs per carton
(uds.)

15

Unidades por pack
Units per pack
(uds.)

5

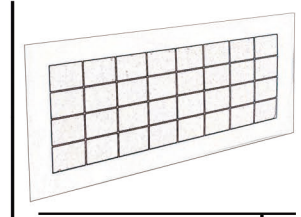

ALTURA/HEIGHT

ANCHO/WIDTH

225mm

240 mm



Referencia
AD0115E

Repuesto parrilla
Spare part insect killer
(ref.)
PA0115E

Packs por caja
Packs per carton
(uds.)

15

Unidades por pack
Units per pack
(uds.)

5

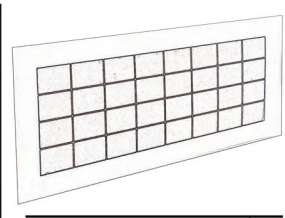

ALTURA/HEIGHT

ANCHO/WIDTH

135mm

380 mm

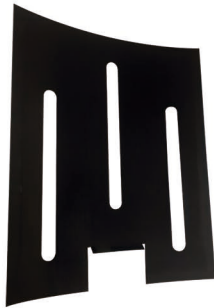

Referencia
AD0117E

Repuesto parrilla
Spare part insect killer
(ref.)
PA0117E

Packs por caja
Packs per carton
(uds.)

14

Unidades por pack
Units per pack
(uds.)

5

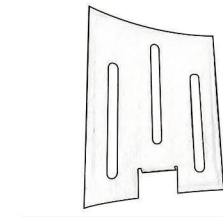

ALTURA/HEIGHT

ANCHO/WIDTH

300 mm

250 mm

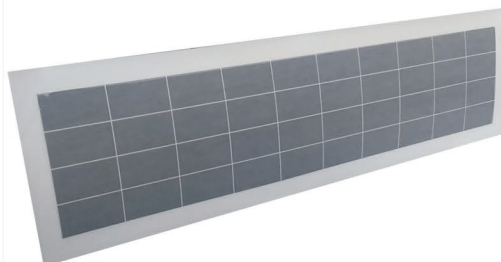

Referencia
AD0218E

Repuesto parrilla
Spare part insect killer
(ref.)
PA0218E

Packs por caja
Packs per carton
(uds.)

14

Unidades por pack
Units per pack
(uds.)

5

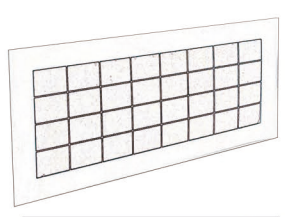

ALTURA/HEIGHT

ANCHO/WIDTH

170 mm

590 mm



DISPENSADORES DE FRAGANCIAS

AIR FRESHENER
DISPENSERS

ELECTRONIC

Tres modelos de dispensadores para fragancias o insecticida en aerosol.

Programables con 4 intervalos de tiempo para adecuarlos a cada momento del día.

Fabricados en ABS y con cerradura de llave especial para montar en pared o sobremesa.

Three models of dispensers for fragrances or aerosol insecticide.

Programmable with 4 time intervals for adapt them to each moment of the day.

Made of ABS and with key lock especially for wall or desktop mounting

ELECTRONIC DISPENSADORES DE FRAGANCIAS

AIR FRESHENER DISPENSERS



Referencia
DA1000



Acabado/Finish

- Fabricado en plástico ABS
- Programable con 3 intervalos de tiempo: 5, 15 y 30 min.
- 3 periodos de funcionamiento día, noche y 24 h.
- Sensor de luz
- Led luminoso indicador de funcionamiento
- Cierre con cerradura y llave
- Opción de montaje de sobremesa y mural
- 2 baterías AALR6 1,5V
- Dimensiones (mm) 225x75x85
- Caja de 20 unidades

- Made in white/grey ABS thermoplastic
- Programmable 3 time intervals 5, 15 and 30 min.
- 3 periods of time: day, night & 24 h.
- Light sensor
- Led type operation indicator light
- Lock system with key
- Free standing or wall-mounting installation
- 2 batteries AALR6 1,5V
- Dimensions (mm) 225x75x85
- 20 units per box



Referencia
DA2000



Acabado/Finish

- Fabricado en plástico PP blanco
- Programable con 4 intervalos de tiempo: 5, 10, 15 y 30 min.
- 3 periodos de funcionamiento día, noche y 24 h.
- Sensor de luz
- Led luminoso indicador de funcionamiento
- Cierre con cerradura y llave
- Opción de montaje de sobremesa y mural
- 2 baterías AALR6 1,5V
- Dimensiones (mm) 207x78x90
- Caja de 50 unidades

- Made in white PP
- Programmable 4 time intervals 5, 10, 15 and 30 min.
- 3 periods of time: day, night & 24 h.
- Light sensor
- Led type operation indicator light
- Lock system with key
- Free standing or wall-mounting installation
- 2 batteries AALR6 1,5V
- Dimensions (mm) 207x78x90
- 50 units per box



Referencia
DA3000



Acabado/Finish

*Disponible hasta agotar existencias

- Fabricado en plástico PP y ABS blanco y frontal negro
- Programable con 4 intervalos de tiempo: 5, 10, 15 y 30 min.
- 3 periodos de funcionamiento día, noche y 24 h.
- Sensor de luz
- Led luminoso indicador de funcionamiento
- Cierre con cerradura y llave
- Opción de montaje de sobremesa y mural
- 2 baterías AALR6 1,5V
- Dimensiones (mm) 247x83x97
- Caja de 40 unidades

- Made in ABS and PP thermoplastic white and black front
- Programmable 4 time intervals 5, 10, 15 and 30 min.
- 3 periods of time: day, night & 24 h.
- Light sensor
- Led type operation indicator light
- Lock system with key
- Free standing or wall-mounting installation
- 2 batteries AALR6 1,5V
- Dimensions (mm) 247x83x97
- 40 units per box



FRAGANCIAS AIR FRESHENER

Presentamos una amplia gama de fragancias para satisfacer las necesidades de cada cliente, así como insecticidas de piretrinas naturales. Aerosoles con gas inocuo e inofensivos para la capa de ozono.

We present a wide range of fragrances for satisfy the needs of each client, as well as insecticity of natural pyrethrins. Aerosols with gas that are harmless and harmless to the ozone layer.



FRAGANCIAS AIR FRESHENER

FRAGANCIAS AIR FRESHENER



Referencia
A1000MA
MANDARINA
MANDARIN



Referencia
A1001AL
ALOE



Referencia
A1002TV
TÉ VERDE
GREE TEEN



Referencia
A1003MG
MANGO



Referencia
A1004TA
TALCO
TALCUM



Referencia
A1006AT
ABSORBE OLORES
ABSORBS ODOURS



Referencia
A1007LI
LIMÓN
LEMON



Referencia
A1008LA
LAVANDA
LAVANDER



Referencia
A1009CZ
CEREZA
CHERRY



Referencia
A1010CN
CANELA
CINNAMON



Referencia
A1011VA
VAINILLA
VANILLA



Referencia
A1012SP
SPA



FRAGANCIAS / AIR FRESHENER

Compatible con nuestro dispensador de aerosol ref. DA1000, DA2000 y DA3000
Compatible with our aerosol dispenser ref. DA1000, DA2000 and DA3000

Volumen Volume (ml)	Descarga por pulsación Pulse discharge (g)	Unidades por caja Units per box (uds)
250	0,065-0,075	12

INSECTICIDA/ INSECTICIDE

- Insecticida en aerosol, con piretrinas naturales
- Gas inócua e inofensivo para la capa de ozono.
- Compatible con nuestro dispensador de aerosol ref. DA1000, DA2000 y DA3000
- Aerosol insecticide, with natural pyrethrins
- Harmless and harmless gas for the ozone layer.
- Compatible with our aerosol dispenser ref. DA1000, DA2000 and DA3000



Referencia
I1000PN



Volumen Volume (ml)	Descarga por pulsación Pulse discharge (g)	Unidades por caja Units per box (uds)
250	0,065-0,075	40



ACCESORIOS DE PROTECCIÓN INFANTIL

CHILD PROTECTION
ACCESSORIES

DIBUS

Con la serie que presentamos a continuación, cubrimos las necesidades en el cuarto de baño a la hora de tener que hacer uso del mismo. Cambiadores y asientos con la máxima protección. Fabricados en polietileno de alta densidad y cinturones de seguridad.

With the series that we present below, we cover the needs in the bathroom at the time of having to make use of it.

Changing tables and seats with maximum protection.

Made of high-density polyethylene and seat belts.

DIBUS ASIENTOS DE PROTECCIÓN INFANTIL CHILD PROTECTION SEAT



SILLA

Referencia

CH1000



Acabado/Finish



- Fabricado en polietileno de alta densidad
- Incorpora cinturón de seguridad
- Eje de la bisagra oculto de acero
- Peso máximo en uso 20 Kg
- Caja de 1 unidad

- Made in high-density polyethylene
- Safety belt incorporated
- Steel open axis hinge
- 20 Kg maximum weight
- 1 units per box.

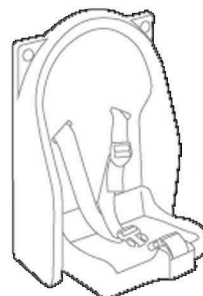

ALTURA/HEIGHT	ANCHO/WIDTH	FONDO/DEPTH
600 mm	310 mm	130 mm
DIMENSIONES CERRADO / DIMENSIONS CLOSED		



CAMBIADOR

Referencia

CH5000

Acabado/Finish



DIMENSIONES CERRADO / DIMENSIONS CLOSED

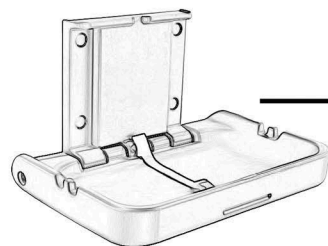

ALTURA/HEIGHT	ANCHO/WIDTH	FONDO/DEPTH
470 mm	820mm	555 mm

· Fabricados en polietileno de alta densidad

· Incorpora cinturón de seguridad

· Bandeja cóncava, sin juntas laterales para bolsas y ranura frontal para una fácil apertura.

· Chasis y bisagra de acero oculto

· Amortiguador neumático para una suave apertura

· Peso máximo en uso 20 Kg

· Caja de 1 unidad

· Made in high-density polyethylene

· Safety belt incorporated

· Concave tray, without joints with side handles for bags

and front slot for easy opening

· Pneumatic damper for smooth opening

· Steel chassis and axis hinge

· 20 Kg maximum weight

· 1 units per box.



CAMBIADOR

Referencia

CH5500

Acabado/Finish



DIMENSIONES CERRADO / DIMENSIONS CLOSED



ALTURA/HEIGHT	ANCHO/WIDTH	FONDO/DEPTH
475 mm	855mm	555 mm



ACCESORIOS DE BAÑO BATH ACCESSORIES LAGA

Amplia gama de accesorios de baño para hoteles y residencias y poder cubrir cualquier necesidad del cuarto de baño.

Fabricados en tubo de Ø 20 de latón con baño de cromo brillo para una mayor duración. Opciones de acabados diferentes bajo pedido.

Wide range of bathroom accessories for hotels and residences and be able to cover any need of the bathroom.

Made of Ø 20 brass tube with bath of Shiny chrome for a longer life.

Different finish options on request.,



Referencia

ACL21213



- Portarollos de reserva horizontal
- Latón Cromado Brillo Ø 20mm
- Dimensiones (mm) 50 x 103 x 210
- Acabados especiales en blanco y negro bajo pedido.

- 90° toilet roll holder
- Bright Chromed Brass Ø 20mm
- Dimensions (mm) 50 x 103 x 210
- Special finishes in whit and black under order



Referencia

ACL21214



- Portarollos de reserva vertical
- Latón Cromado Brillo Ø 20mm
- Dimensiones (mm) 50 x 103 x 210
- Acabados especiales en blanco y negro bajo pedido.

- Spare toilet roll holder
- Bright Chromed Brass Ø 20mm
- Dimensions (mm) 50 x 103 x 210
- Special finishes in whit and black under order



Referencia

ACL21215



- Portarollos de reserva vertical con anilla
- Latón Cromado Brillo Ø 20mm
- Dimensiones (mm) 50 x 103 x 210
- Acabados especiales en blanco y negro bajo pedido.

- 90° toilet roll holder
- Bright Chromed Brass Ø 20mm
- Dimensions (mm) 50 x 103 x 210
- Special finishes in whit and black under order



Referencia

ACL207



- Percha simple de tapón
- Latón Cromado Brillo Ø 20mm
- Dimensiones (mm) 50 x 50 x 49
- Acabados especiales en blanco y negro bajo pedido.

- Single robe short
- Bright Chromed Brass Ø 20mm
- Dimensions (mm) 50 x 50 x 49
- Special finishes in whit and black under order



Referencia

ACL213



- Percha simple en angulo recto
- Latón Cromado Brillo Ø 20mm
- Dimensiones (mm) 50 x 78 x 85
- Acabados especiales en blanco y negro bajo pedido.

- 90° single robe hook
- Bright Chromed Brass Ø 20mm
- Dimensions (mm) 50 x 78 x 85
- Special finishes in whit and black under order

LAGA ACCESORIOS DE BAÑO

BATH ACCESSORIES



Referencia

ACL25250



- Toallero repisa de 2 apoyos con barra
- Latón Cromado Brillo Ø 20mm
- Dimensiones (mm) 525 x 230 x 115
- Acabados especiales en blanco y negro bajo pedido.

- Towelshelf with single towel rail 2 anchors
- Bright Chromed Brass Ø 20mm
- Dimensions (mm) 525 x 230 x 115
- Special finishes in whit and black under order



Referencia

ACL25350



- Toallero repisa de 4 apoyos con barra
- Latón Cromado Brillo Ø 20mm
- Dimensiones (mm) 525 x 230 x 140
- Acabados especiales en blanco y negro bajo pedido.

- Towelshelf with single towel rail 4 anchors
- Bright Chromed Brass Ø 20mm
- Dimensions (mm) 525 x 230 x 140
- Special finishes in whit and black under order



Referencia

ACL22445



- Toallero barra de 45 cm.
- Latón Cromado Brillo Ø 20mm
- Dimensiones (mm) 480 x 75 x 50
- Acabados especiales en blanco y negro bajo pedido.

- Single towl rail 45 cm.
- Bright Chromed Brass Ø 20mm
- Dimensions (mm) 480 x 75 x 50
- Special finishes in whit and black under order



Referencia

ACL22460



- Toallero barra de 60 cm.
- Latón Cromado Brillo Ø 20mm
- Dimensiones (mm) 630 x 75 x 50
- Acabados especiales en blanco y negro bajo pedido.

- Single towel rail 60 cm.
- Bright Chromed Brass Ø 20mm
- Dimensions (mm) 630 x 75 x 50
- Special finishes in whit and black under order



Referencia

ACL210



- Toallero de anilla abierta
- Latón Cromado Brillo Ø 20mm
- Dimensiones (mm) 225 x 175 x 69
- Acabados especiales en blanco y negro bajo pedido.

- Open towel ring
- Bright Chromed Brass Ø 20mm
- Dimensions (mm) 225 x 175 x 69
- Special finishes in whit and black under order



ACCESORIOS DE BAÑO BATH ACCESSORIES TONDA

Amplia gama de accesorios de baño para hoteles y residencias y poder cubrir cualquier necesidad del cuarto de baño.

Fabricados en tubo de Ø 20 de latón con baño de cromo brillo para una mayor duración.

Opciones de acabados diferentes bajo pedido.

Wide range of bathroom accessories for hotels and residences and be able to cover any need of the bathroom.

Made of Ø 20 brass tube with bath of Shiny chrome for a longer life.

Different finish options

TONDA ACCESORIOS DE BAÑO

BATH ACCESSORIES



Referencia

ACL211



- **Portarrollos con tapa**
- **Latón Cromado Brillo Ø 20mm**
- **Dimensiones (mm) 130 x 130 x 67**
- **Acabados especiales en blanco y negro bajo pedido.**

- Toilet rail holder with cover
- Bright Chromed Brass Ø 20mm
- Dimensions (mm) 130 x 130 x 67
- Special finishes in whit and black under order



Referencia

ACT21114



- **Portarrollos de reserva vertical**
- **Latón Cromado Brillo Ø 20mm**
- **Dimensiones (mm) 50 x 103 x 210**
- **Acabados especiales en blanco y negro bajo pedido.**

- Spare toilet roll holder
- Bright Chromed Brass Ø 20mm
- Dimensions (mm) 50 x 103 x 210
- Special finishes in whit and black under order



Referencia

ACT21306



- **Percha simple**
- **Latón Cromado Brillo Ø 20mm**
- **Dimensiones (mm) 50 x 78 x 85**
- **Acabados especiales en blanco y negro bajo pedido.**

- Single robe hook
- Bright Chromed Brass Ø 20mm
- Dimensions (mm) 50 x 78 x 85
- Special finishes in whit and black under order



Referencia

ACT21411



- **Percha doble**
- **Latón Cromado Brillo Ø 20mm**
- **Dimensiones (mm) 166 x 69 x 50**
- **Acabados especiales en blanco y negro bajo pedido.**

- Double robe root
- Bright Chromed Brass Ø 20mm
- Dimensions (mm) 166 x 69 x 50
- Special finishes in whit and black under order



Referencia

ACT208



- **Percha doble**
- **Latón Cromado Brillo Ø 20mm**
- **Dimensiones (mm) 60 x 72 x 50**
- **Acabados especiales en blanco y negro bajo pedido.**

- Double robe root
- Bright Chromed Brass Ø 20mm
- Dimensions (mm) 60 x 72 x 50
- Special finishes in whit and black under order

TONDA ACCESORIOS DE BAÑO

BATH ACCESSORIES



Referencia

ACT20425



- Toallero barra 30cm
- Latón Cromado Brillo Ø 20mm
- Dimensiones (mm) 330 x 75 x 50
- Acabados especiales en blanco y negro bajo pedido.

- Singel towel rail 30 cm
- Bright Chromed Brass Ø 20mm
- Dimensions (mm) 330 x 75 x 50
- Special finishes in whit and black under order



Referencia

ACT22445



- Toallero barra 45 cm.
- Latón Cromado Brillo Ø 20mm
- Dimensiones (mm) 480 x 75 x 50
- Acabados especiales en blanco y negro bajo pedido.

- Singel towel rail 45 cm.
- Bright Chromed Brass Ø 20mm
- Dimensions (mm) 480 x 75 x 50
- Special finishes in whit and black under order



Referencia

ACT22460



- Toallero barra 60 cm.
- Latón Cromado Brillo Ø 20mm
- Dimensiones (mm) 630 x 75 x 50
- Acabados especiales en blanco y negro bajo pedido.

- Single towel rail 60 cm.
- Bright Chromed Brass Ø 20mm
- Dimensions (mm) 630 x 75 x 50
- Special finishes in whit and black under order



Referencia

ACT25150



- Toallero repisa pletinas de 4 apoyos con barra
- Latón Cromado Brillo Ø 20mm
- Dimensiones (mm) 505 x 255 x 117
- Acabados especiales en blanco y negro bajo pedido.

- Towelshelf with single towel rail 4 archors
- Bright Chromed Brass Ø 20mm
- Dimensions (mm) 505 x 255 x 117
- Special finishes in whit and black under order



**COMPLEMENTOS
DE DUCHA**
BATH
COMPLEMENTS

COMPLEMENTOS DE DUCHA

BATH COMPLEMENTS



Referencia

ACT20535



- Asa bañera curva brillo Ø 25 mm
- Dimensiones (mm) 393 x 245 x 83
- Acabados especiales en blanco y negro bajo pedido.

- Angled grab rail bright Ø 25mm
- Dimensions (mm) 393 x 245 x 83
- Special finishes in whit and black under order



Referencia

ACT20635



- Asa bañera curva con jabonera brillo Ø 25mm
- Dimensiones (mm) 393 x 245 x 83
- Acabados especiales en blanco y negro bajo pedido.

- Angled grab rail with soap rack bright Ø 25mm
- Dimensions (mm) 393 x 245 x 83
- Special finishes in whit and black under order



Referencia

ACT20425



- Asa recta 30 cm brillo Ø 25mm
- Dimensiones (mm) 393 x 245 x 83
- Acabados especiales en blanco y negro bajo pedido.

- Right grab rail 30 cm bright .Ø 25mm
- Dimensions (mm) 393 x 245 x 83
- Special finishes in whit and black under order

Referencia

ACJ4055BR



Referencia

ACJ4055BR



- Jabonera rincón acero inoxidable.
- Acabado en BRILLO o SATINADO
- Dimensiones (mm) 225 x 105 x 18
- Acabados especiales en blanco y negro bajo pedido.

- Corner shower basket stainless
- Finish in BRIGHT or SATIN
- Dimensions (mm) 225 x 105 x 18
- Special finishes in whit and black under order



**ESPEJOS Y
DISPENSADORES
MIRRORS & DISPENSERS**

ESPEJOS Y DISPENSADORES

MIRRORS & DISPENSERS



Referencia

AC296BR



- **Espejo de aumento x5 de pared con doble brazo articulado**
- **2 caras/ diametro espejo Ø 20mm**
- **Dimensiones (mm) 465 x 307 x 30**
- **Acabados especiales en blanco y negro bajo pedido**

- World mount magnifying mirror x5 with double arm articulated
- 2 side / mirror diameter Ø 20mm
- Dimensions (mm) 465 x 307 x 30
- Special finishes in whit and black under order



Referencia

AC297BR



- **Espejo de aumento x3 de pared con doble brazo articulado**
- **1 cara/ diametro espejo Ø 20mm**
- **Dimensiones (mm) 260 x 220 x 100**
- **Acabados especiales en blanco y negro bajo pedido**

- World mount magnifying mirror x3 with double arm articulated
- 1side / mirror diameter Ø 20mm
- Dimensions (mm) 260 x 220 x 100
- Special finishes in whit and black under order



Referencia

ACD4000



- **Dispensador de bolsitas higiénicas**
- **Dimensiones (mm) 145 x 110 x 38**
- **Acabados especiales en blanco y negro bajo pedido.**

- Sanitary bag dispensers
- Dimensions (mm) 145 x 110 x 38
- Special finishes in whit and black under order



Referencia

ACD5000



- **Dispensador de bolsitas hijiénicas**
- **Dimensiones (mm) 125 x 125 x 132**
- **Acabados especiales en blanco y negro bajo pedido.**

- Sanitary bag dispensers
- Dimensions (mm) 125 x 125 x 132
- Special finishes in whit and black under order



Referencia

ACD6000



- **Dispensador de toallas faciales**
- **Dimensiones (mm) 140 x 60 x 256**
- **Acabados especiales en blanco y negro bajo pedido.**

- Facial tissue dispenser
- Dimensions (mm) 140 x 60 x 256
- Special finishes in whit and black under order



**DISPENSADOR
BOLSAS HIGIÉNICAS
HYGIENIC BAR
DISPENSER**

TRENDY

TRENDY DISPENSADOR BOLSITAS HIGIÉNICAS

HYGIENICS BAGS DISPENSERS



Referencia

B1100PG



Acabado/Finish

PG

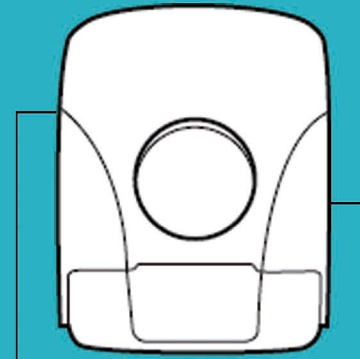

ALTURA/HEIGHT	ANCHO/WIDTH	FONDO/DEPTH
175 mm	135 mm	145 mm

Capacidad bolsas
Bags capacity
(uds)

25

Dimensiones bolsa
Bag dimensions
(mm)

26 x 7 x7



Referencia

B1100PP



Acabado/Finish

PP

- Fabricados en ABS antiestático
- Sistema de cerradura con llave CLAR
- Caja de 26 unidades

- Made in antistatic ABS plastic
- Lock system with CLAR key
- 26 units per box



Referencia

RB026

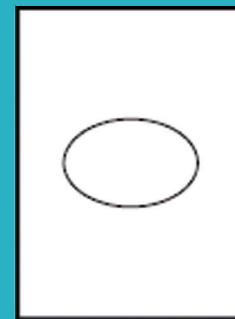

ALTURA/HEIGHT	ANCHO/WIDTH	FONDO/DEPTH
125 mm	90 mm	15mm

Capacidad bolsas
Bags capacity
(uds)

25

Dimensiones bolsa
Bag dimensions
(mm)

26 x 7 x7

Unidades por caja
Units per box
(uds)

48



COMPLEMENTOS ACCESORIES

COMPLEMENTOS ACCESSORIES



- Escobillero suelo-pared con vaso extraíble acero inox **BRILLO** o **SATINADO**
- Dimensiones (mm) 92 x 92 x 430
- Acabados especiales en blanco y negro bajo pedido.
- BRIGHT or SATIN stainless steel wall mounted toilet brush holder with removable inner part
- Dimensions (mm) 50 x 103 x 210
- Special finishes in white and black under order



Dimensiones (mm)
Ø250 x 300 x 400



Dimensiones (mm)
Ø205 x 280 x 290



Dimensiones (mm)
Ø170 x 220 x 245

- Papelera de pedal 3/5/12 L. acero inox **BRILLO** o **SATINADO**
- Acabados especiales en blanco y negro bajo pedido.

- BRIGHT or SATIN stainless steel pedal bin 3/5/12L.
- Special finishes in white and black under order



Referencia
PM2000W

- Soporte maletas en madera lacada
- Dimensiones (mm) 630 x 425 x 420

- Varnished pine wood luggage rack
- Dimensions (mm) 630 x 425 x 420



Referencia
PM3000BR

- Soporte maletas en tubo de acero cuadrado cromado.
- Dimensiones (mm) 630 x 425 x 420

- Square folding luggage rack chromed stell
- Dimensions (mm) 630 x 425 x 420



AYUDAS TÉCNICAS

TECHNICAL AIDS

Amplia gama de ayudas técnicas fabricadas en acero inoxidable, en acabados brillo y satinado. Opciones de acabados en blanco y nylon bajo pedido.

Wide range of technical aids manufactured in stainless steel, in gloss and satin finishes. Nylon and White Finish Options, Low order.,



AYUDAS TÉCNICAS

TECHNICAL AIDS



Referencia
BA701SA



- Asidero abatible 70 cm acero inox satinado
- Dimensiones (mm) 700
- Removable folding 70cm satin stainless steel
- Dimensions (mm) 700



Referencia
BAP701SA



- Asidero abatible con portarrollos 70 cm acero inox satinado
- Dimensiones (mm) 700
- Removable folding with paper holder 70cm satin stainless steel
- Dimensions (mm) 700



Referencia
BAS701SA



- Asidero abatible con y pata articulada 70 cm acero inox satinado
- Dimensiones (mm) 700
- Removable folding with paper holder and support leg 70cm satin stainless steel



Referencia
BR401SA



Dimensiones (mm)
400

Referencia
BR501SA



Dimensiones (mm)
500

Referencia
BR601SA



Dimensiones (mm)
600

- Asidero recto 40 / 50 / 60 cm acero inox satinado
- Acabados especiales en blanco y blanco/nylon bajo pedido.

- Grab rail 40 / 50 / 60 cm satin stainless steel
- Special finishes in white and white/nylon under order



Referencia
BA9050SA



- Asidero 90° 50 x50 cm. acero inox satinado
- Dimensiones (mm) 500x 500
- Acabados especiales en blanco y blanco/nylon bajo pedido.

- 90° angled grab rail 50x50 cm satin stainless steel
- Dimensions (mm) 500 x 500
- Special finishes in white and white/nylon under order



Referencia
AB350SA



- Asiento de ducha con bastidor acero inox satinado
- Dimensiones (mm) 350 x 350
- Acabados especiales en blanco y blanco/nylon bajo pedido.

- Foldin shower seat with base satin stainless steel
- Dimensions (mm) 350 x 350
- Special finishes in white and white/nylon under order

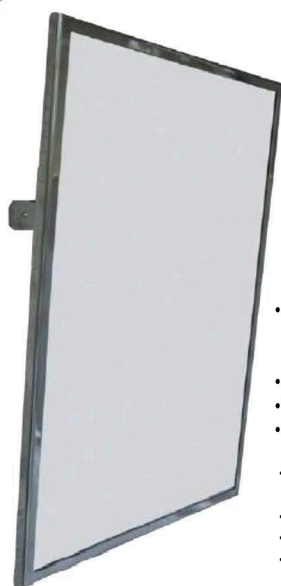

Referencia
ESPR7050ACI



- Espejo reclinado fabricado en vidrio de seguridad vitrificado con marco de acero inox satinado.
- Compases especiales para reclin.
- Especial para cuartos de baño adaptados.
- Fabricado conforme a la norma DIN.

- Reclining mirror made of glass safety glass with frame satin stainless steel.
- Special compasses for reclining.
- Special for adapted bathrooms.
- Manufactured according to DIN standard.



Referencia
ESPR7050SM



- Espejo reclinado fabricado en vidrio de seguridad vitrificado con marco de acero inox satinado.
- Compases especiales para reclin.
- Especial para cuartos de baño adaptados.
- Fabricado conforme a la norma UNE7697.

- Reclining mirror made of glass safety glass with frame satin stainless steel.
- Special compasses for reclining.
- Special for adapted bathrooms.
- Manufactured according to UNE7697 standard.



Fabricante de calidad
Marca España

Made in Spain
quality Manufacturer



Polígono Industrial de Babel
Calle de las Artes Gráficas, 12B
03008 Alicante
Teléfono: [+34] 965 10 77 08
info@clarystems.com